

JVC



MICRO COMPONENT SYSTEM

UX-P550

—Consists of CA-UXP550 and SP-UXP550

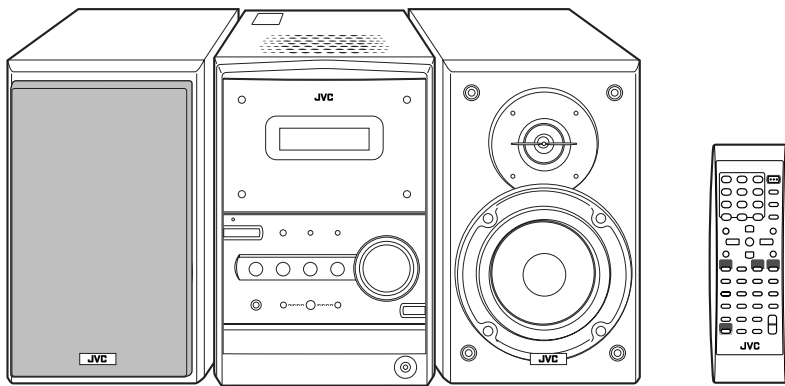

INSTRUCTIONS

GVT0130-003A

[B]

Warnings, Cautions and Others

IMPORTANT for the U.K.

DO NOT cut off the mains plug from this equipment. If the plug fitted is not suitable for the power points in your home or the cable is too short to reach a power point, then obtain an appropriate safety approved extension lead or consult your dealer.

BE SURE to replace the fuse only with an identical approved type, as originally fitted.

If nonetheless the mains plug is cut off ensure to remove the fuse and dispose of the plug immediately, to avoid a possible shock hazard by inadvertent connection to the mains supply.

If this product is not supplied fitted with a mains plug then follow the instructions given below:

IMPORTANT:

DO NOT make any connection to the terminal which is marked with the letter E or by the safety earth symbol or coloured green or green-and-yellow.

The wires in the mains lead on this product are coloured in accordance with the following code:

Blue: Neutral
Brown: Live

As these colours may not correspond with the coloured markings identifying the terminals in your plug proceed as follows:

The wire which is coloured blue must be connected to the terminal which is marked with the letter N or coloured black.

The wire which is coloured brown must be connected to the terminal which is marked with the letter L or coloured red.

IF IN DOUBT - CONSULT A COMPETENT ELECTRICIAN.

CAUTION—STANDBY/ON button!

Disconnect the mains plug to shut the power off completely (all lamps and indications go off). The STANDBY/ON  button in any position does not disconnect the mains line.

- When the unit is on standby, the STANDBY/ON lamp lights in red.
- When the unit is turned on, the STANDBY/ON lamp lights in green.

The power can be remote controlled.

CAUTION

To reduce the risk of electrical shocks, fire, etc.:

1. Do not remove screws, covers or cabinet.
2. Do not expose this appliance to rain or moisture.

IMPORTANT FOR LASER PRODUCTS

1. CLASS 1 LASER PRODUCT
2. **CAUTION:** Do not open the top cover. There are no user serviceable parts inside the unit; leave all servicing to qualified service personnel.
3. **CAUTION:** Visible and invisible laser radiation when open and interlock failed or defeated. Avoid direct exposure to beam.
4. REPRODUCTION OF LABEL: CAUTION LABEL, PLACED INSIDE THE UNIT.

CAUTION : Visible and invisible laser radiation when open and interlock failed or defeated. AVOID DIRECT EXPOSURE TO BEAM.	ADVARSEL : Synlig og usynlig laserstråling når maskinen er åben eller interlocken fejler. Undgå direkte eksponering til strålingen.	WARNING : Synlig och osynlig laserstråling när den öppnas och spärrar är urkopplad. Betrakta ej strålen.	VARO : Asetuksessa ja suojauksissa ohjeittuna tai välisellä olet alittuna näkyväille ja näkymättömille lasersäteilylle. Vältä säteen kohdistumista suoraan iiseesi. (fi)
---	--	---	---

CAUTION

- Do not block the ventilation openings or holes. (If the ventilation openings or holes are blocked by a newspaper or cloth, etc., the heat may not be able to get out.)
- Do not place any naked flame sources, such as lighted candles, on the apparatus.
- When discarding batteries, environmental problems must be considered and local rules or laws governing the disposal of these batteries must be followed strictly.
- Do not expose this apparatus to rain, moisture, dripping or splashing and that no objects filled with liquids, such as vases, shall be placed on the apparatus.

Caution: Proper Ventilation

To avoid risk of electric shock and fire, and to prevent damage, locate the apparatus as follows:

1. Front: No obstructions and open spacing.
2. Sides/ Top/ Back: No obstructions should be placed in the areas shown by the dimensions below.
3. Bottom: Place on the level surface. Maintain an adequate air path for ventilation by placing on a stand with a height of 10 cm or more.

Front view

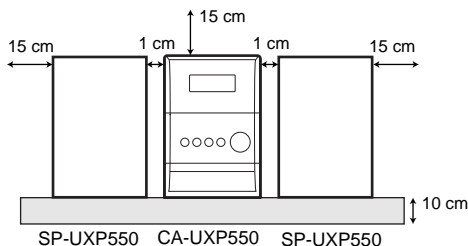

Side view

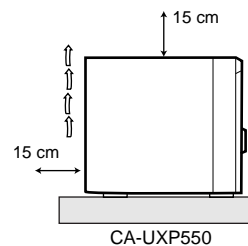

Contents



Introduction	2	Unique DVD/VCD Operations.....	20
Precautions	2	Selecting the View Angle.....	20
How to Read This Manual.....	2	Selecting the Subtitle Language	20
Getting Started.....	3	Selecting the Audio Track	21
Step 1: Unpack	3	Playing Back a Bonus Group	21
Step 2: Prepare the Remote Control	3	Special Effect Playback.....	22
Step 3: Hook Up	4	Advanced Disc Operations	23
Selecting the Video Signal	6	Programming the Playing Order—Program Play	23
Changing the Scanning Mode	6	Playing at Random—Random Play	24
Before Operating the System.....	7	Playing Repeatedly	25
Playable Disc Types	7	Prohibiting Disc Ejection—Child Lock	25
Display Indicators.....	8	On-Screen Disc Operations	26
Daily Operations—Playback	10	On-screen Bar Information.....	26
Listening to the Radio	11	Operations Using the On-screen Bar	27
Playing Back a Disc.....	12	Selecting Browsable Still Pictures.....	29
Daily Operations—Sound & Other		Operations on the CONTROL Screen.....	29
Adjustments	14	Timer Operations	31
Adjusting the Volume.....	14	Setting the Timer	31
Adjusting the Sound	14	Setup Menu Operations.....	33
Presetting Automatic DVD Video		Operating Procedure	33
Sound Increase Level.....	15	Restricting the Review—Parental Lock	37
Changing the Display Brightness	15	Additional Information.....	39
Changing the Picture Tone	15	Learning More about This System	39
Setting the Clock	16	Maintenance	40
Turning Off the Power Automatically.....	16	Troubleshooting.....	41
Advanced Radio Operations.....	17	Language Code List.....	42
Receiving FM Stations with RDS	17	Country/Area Codes List.....	43
Searching for a Program by PTY Codes	17	DVD OPTICAL DIGITAL OUT Signals	44
Switching Temporarily to a Program of Your Choice		Specifications	45
Automatically	18	Parts Index	45

Introduction

Precautions

Installation

- Install in a place which is level, dry and neither too hot nor too cold—between 5°C and 35°C.
- Install the System in a location with adequate ventilation to prevent internal heat buildup inside the System.



DO NOT install the System in a location near heat sources, or in a place subject to direct sunlight, excessive dust or vibration.

- Leave sufficient distance between the System and the TV.
- Keep the speakers away from the TV to avoid interference with TV.

Power sources

- When unplugging the System from the wall outlet, always pull on the plug, not the AC power cord.



DO NOT handle the AC power cord with wet hands.

Moisture condensation

Moisture may condense on the lenses inside the System in the following cases:

- After starting to heat the room
- In a damp room
- If the System is brought directly from a cold to a warm place

Should this occur, the System may malfunction. In this case, leave the System turned on for a few hours until the moisture evaporates, unplug the AC power cord, then plug it in again.

Others

- Should any metallic object or liquid fall into the System, unplug the AC power cord and consult your dealer before operating any further.



DO NOT disassemble the System since there are no user serviceable parts inside.

- If you are not going to operate the System for an extended period of time, unplug the AC power cord from the wall outlet.

If anything goes wrong, unplug the AC power cord and consult your dealer.

How to Read This Manual

To make this manual as simple and easy-to-understand as possible, we have adapted the following methods:

- Button and control operations are explained as listed in the table below.
- **Some related tips and notes are explained later in the sections “Additional Information” and “Troubleshooting,” but not in the same section explaining the operations.** If you want to know more about the functions, or if you have a doubt about the functions, go to these sections and you will find the answers.

	Indicates that you press the button briefly .
	Indicates that you press the button briefly and repeatedly until an option you want is selected.
	Indicates that you press one of the buttons.
	Indicates that you press and hold the button for specified seconds. <ul style="list-style-type: none"> • The number inside the arrow indicates the period of press (in this example, 2 seconds). • If no number is inside the arrow, press and hold until the entire procedure is complete or until you get a result you want.
	Indicates that you turn the control toward the specified direction(s).

	Indicates that this operation is only possible using the remote control.
	Indicates that this operation is only possible using the buttons and controls on the main unit.

Getting Started

Step 1: Unpack the package and check the accessories.

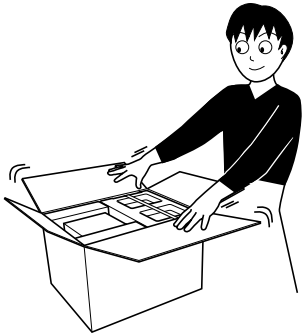

Step 1: Unpack

After unpacking, check to be sure that you have all the following items. The number in parentheses indicates the quantity of each piece supplied.

- FM antenna (1)
- AM loop antenna (1)
- Remote control (1)
- Batteries (2)

If any item is missing, consult your dealer immediately.

Step 2: Prepare the Remote Control

Insert the batteries into the remote control by matching the polarity (+ and -) correctly.

Step 2: Prepare the remote control.

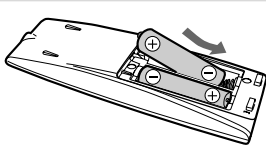

1

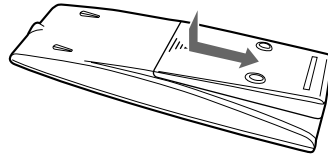

2

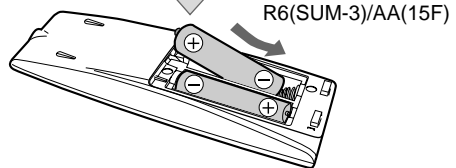

3

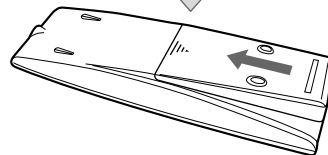

Step 3: Hook up the components such as AM/FM antennas, speakers, etc. (see pages 4 to 6).

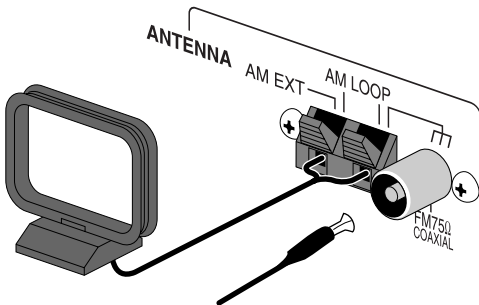

Finally plug the AC power cord.
Now you can operate the System.



- DO NOT use an old battery together with a new one.
- DO NOT use different types of batteries together.
- DO NOT expose batteries to heat or flame.
- DO NOT leave the batteries in the battery compartment when you are not going to use the remote control for an extended period of time. Otherwise, the remote control will be damaged from battery leakage.

Step 3: Hook Up

If you need more detailed information, see page 6.

Illustrations of the input/output terminals below are typical examples. When you connect other components, refer also to their manuals since the terminal names actually printed on the rear may vary.

Turn the power off to all components before connections.

Before connecting optical digital cord

Remove the protective cap from the DVD OPTICAL DIGITAL OUT terminal.

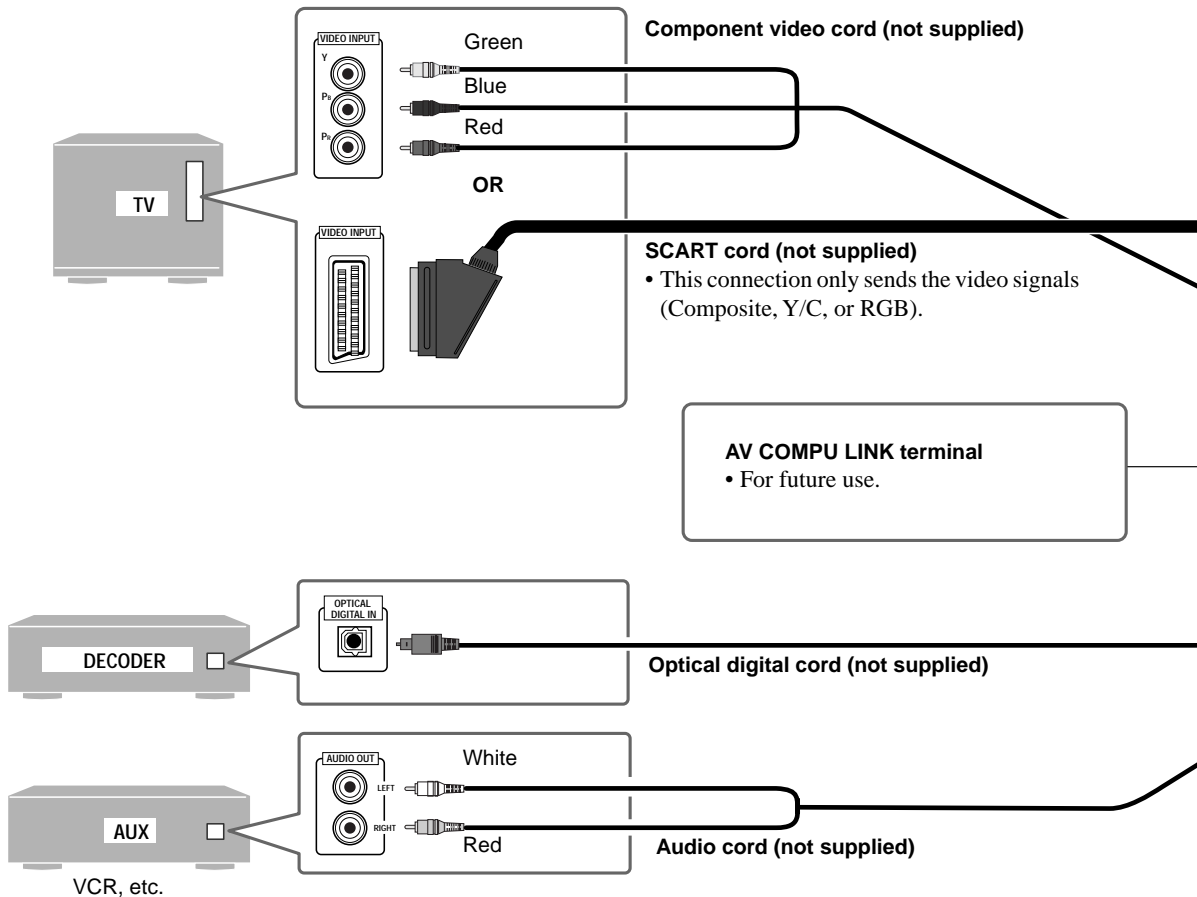
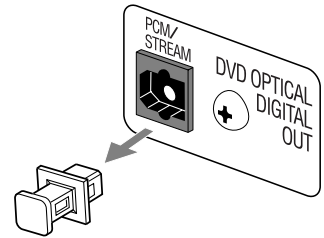

For better FM/AM reception

Outdoor FM antenna (not supplied)

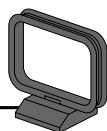
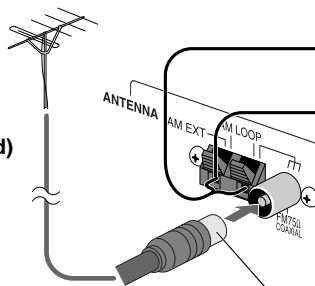

AM loop antenna
Keep it connected.

Vynile-covered wire (not supplied)
Extend it horizontally.

Disconnect the supplied FM antenna, and connect to an outdoor FM antenna using a 75 Ω wire with coaxial type connector (IEC or DIN45325).

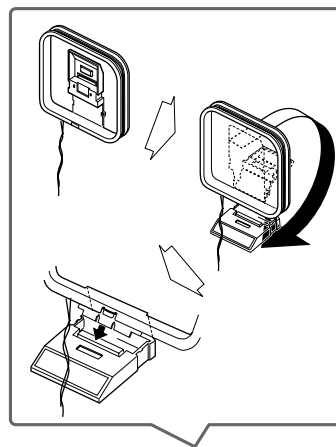

FM antenna (supplied)
Extend it so that you can obtain the best reception.

AM loop antenna (supplied)
Turn it until the best reception is obtained.

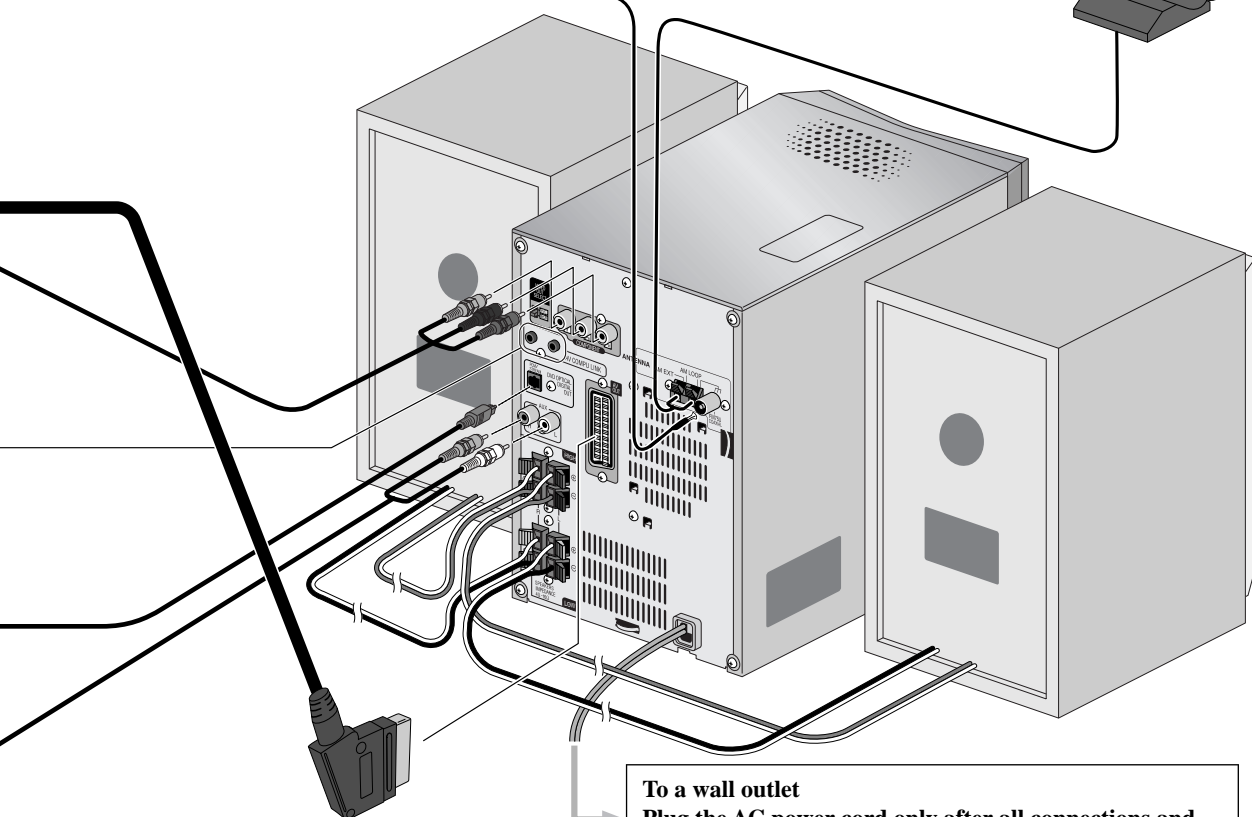

To a wall outlet
Plug the AC power cord only after all connections and selector settings on the rear are complete.

To connect the AM loop antenna

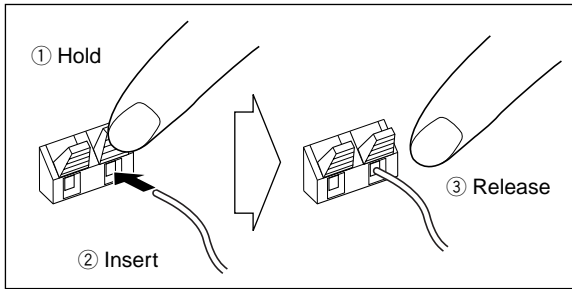

- If the AM loop antenna wire or speaker cords are covered with vinyl, remove the vinyl to expose the tip of the antenna by twisting the vinyl.
- Make sure the antenna conductors do not touch any other terminals, connecting cords and power cord. Also, keep the antennas away from metallic parts of the System, connecting cords, and the AC power cord. This could cause poor reception.

To connect the speaker cords

Connect the right speaker to the RIGHT terminals, and the left speaker to the LEFT terminals.

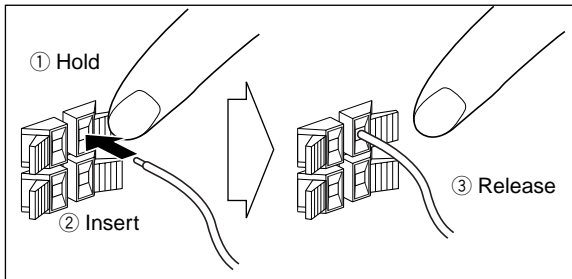

When connecting the speaker cords, match the polarity of the speaker terminals:

- For LOW terminals: Red cord to (+) and black cord to (-).
- For HIGH terminals: Grey cord to (+) and blue cord to (-).



- DO NOT connect more than one speaker to each terminal.
- DO NOT allow the conductor of the speaker cords to be in touch with the metallic parts of the System.

Selecting the Video Signal



When connecting a TV, you can use either one of the video output terminals—COMPONENT or AV OUT. After connecting the TV, set the video signal type correctly for your TV.

- Make sure the unit is not yet turned on. If it is already turned on, turn off then on again so that the selector setting becomes active.

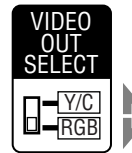

Y/C Select for sending S-Video signals through the AV OUT terminal or for sending component video signals through the COMPONENT jacks.

RGB Select for sending the composite video signals or RGB signals through the AV OUT terminal.

Changing the Scanning Mode



This System supports progressive scanning.

If you connect a progressive TV through the COMPONENT jacks, you can enjoy a high quality picture from the built-in DVD player by selecting “PROGRE.”

- If the VIDEO OUT SELECT switch is not set to “Y/C,” this function does not work.

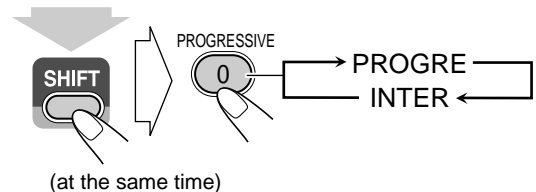





PROGRE Progressive scanning. For a progressive TV.

INTER Interlaced scanning. For a conventional TV.

Before Operating the System

Playable Disc Types

This unit has been designed to play back the following discs:

Disc Type	Mark (Logo)	Video Format	Region Code* Number
DVD Video		PAL	2 or ALL
DVD Audio			
Video CD (VCD)			—
Super Video CD (SVCD)			—
Audio CD		—	—
CD-R	The System can play back CD-R or CD-RW recorded in the Audio CD, Video CD, SVCD, MP3, WMA, and JPEG formats.		
CD-RW			
DVD-R	The System can play back DVD-R or DVD-RW recorded in the video format.		
DVD-RW			

In addition to the above discs, this System can play back audio data recorded on CD Text, CD-G (CD Graphics), and CD-Extra.

- The following discs cannot be played back: DVD-ROM, DVD-RAM, DVD+R, DVD+RW, CD-I (CD-Ready), CD-ROM, Photo CD, etc. Playing back these discs will generate noise and damage the speakers.
- In this manual, “file” and “track” are interchangeably used for MP3/WMA/JPEG operations.

* Note on Region Code

DVD players and DVDs have their own Region Code numbers. This System can play back only DVDs recorded with the PAL color system whose Region Code numbers including “2.” EX.:



If a DVD with the improper Region Code numbers is loaded, “RGN ERR (Region Code Error)” appears on the display and playback will not start.

DVD Video—digital audio formats

The System can play back the following digital audio formats.

- Linear PCM:** Uncompressed digital audio, the same format used for CDs and most studio masters.
- Dolby Digital:** Compressed digital audio, developed by Dolby Laboratories, which enables multi-channel encode to create the realistic surround sound.
- DTS (Digital Theater Systems):** Compressed digital audio, developed by Digital Theater Systems, Inc., which enables multi-channel like Dolby Digital. As the compression ratio is lower than for Dolby Digital, it provides wider dynamic range and better separation.

When playing a multi-channel encoded DVD, the System properly converts these multi-channel signals into 2 channels, and emits the downmixed sound from the speakers.

- To enjoy the powerful sound of these multi-channel encoded DVDs,** connect a proper decoder or an amplifier with a proper built-in decoder to the digital output terminal on the rear.

IMPORTANT: Before playing a disc, make sure of the following...

- Turn on the TV and select an appropriate input mode on the TV to view the pictures or on-screen displays on the TV screen.
- For disc playback, you can change the initial setting to your preference. See “Setup Menu Operations” on page 33.

If “⊗” appears on the TV screen when you press a button, the disc cannot accept the operation you have tried to do, or data required for that operation is not recorded on the disc.

- Manufactured under license from Dolby Laboratories. “Dolby”, “Pro Logic”, “MLP Lossless”, and the double-D symbol are trademarks of Dolby Laboratories.
- “DTS” and “DTS2.0+DIGITAL OUT” are registered trademarks of Digital Theater Systems, Inc.



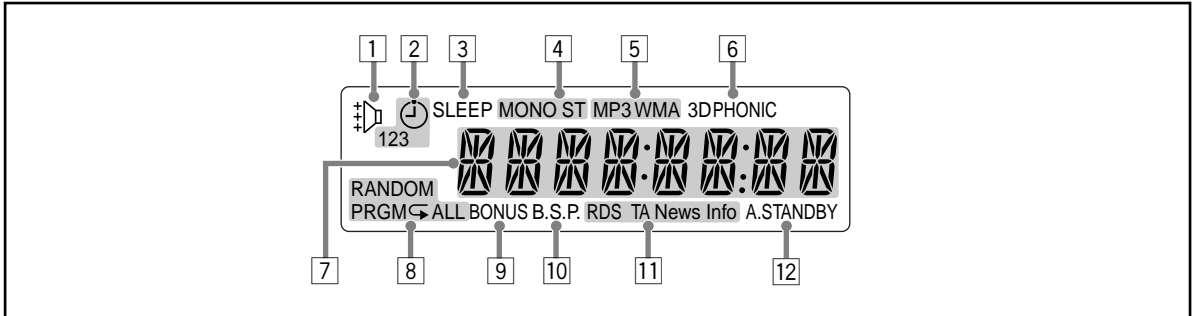

Display Indicators

The indications on the display teach you a lot of things while you are operating the System. Before operating the System, be familiar with when and how the indicator illuminates on the display.

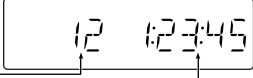
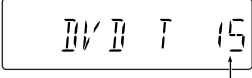
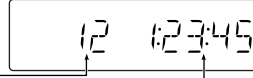
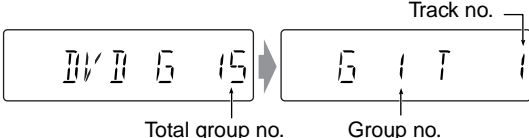
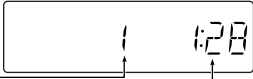
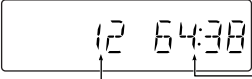

- 1 Rhythm Ax indicator
 - Lights when Rhythm Ax is activated.
- 2 Daily Timer indicators
 - ☺ : lights when Daily Timer stands by or is being preset.
 - 1/2/3: lights when a Daily Timer (1, 2, or 3) stands by; flashes while setting or working.
- 3 SLEEP indicator
 - Lights when the Sleep Timer is activated.
- 4 FM reception indicators
 - MONO: lights while receiving an FM stereo station in monaural.
 - ST (stereo): lights while an FM stereo station with sufficient signal strength is tuned in.
- 5 MP3/WMA indicators
 - MP3: lights when an MP3 track is detected.
 - WMA: lights when a WMA track is detected.
- 6 3D PHONIC indicator
 - Lights when 3D Phonic is activated.
- 7 Main display
 - While listening to radio: Band (or preset number) and station frequency appear.
 - While selecting “AUX”: “AUX” appears.
 - While playing a disc: See “Indications on the main display while operating a disc” on page 9.
- 8 Disc operation indicators
 - RANDOM: lights when Random Play is activated.
 - PRGM (program): lights when Program Play is activated.
 - ↻ (repeat)/ALL:
 - ↻ ALL : lights when Disc Repeat is activated.
 - ↻ : lights when any Repeat other than the above is activated.
- 9 BONUS indicator
 - Lights when a DVD Audio with a bonus group is detected.
- 10 B.S.P. (Browsable Still Picture) indicator
 - Lights when Browsable Still Pictures are detected while playing a DVD Audio.
- 11 RDS (Radio Data System) indicators
 - RDS: lights when an FM station sending RDS signals is tuned in.
 - TA/News/Info—Program type (PTY) indicator:
 - Lights to indicate the currently selected program type for PTY Standby Reception.
 - Flashes when a program is automatically tuned in with PTY Standby Reception.
- 12 A(auto). STANDBY indicator
 - Lights when Auto Standby is activated.
 - Flashes when disc playback stops with Auto Standby activated.

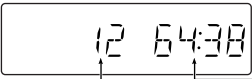
Indications on the main display while operating a disc

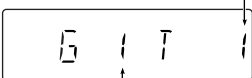
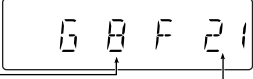
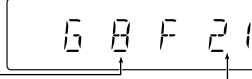
While playing back a disc:	While disc play is stopped:
<ul style="list-style-type: none"> DVD Video:  <p>Current chapter no. Elapsed playing time</p> By pressing DISPLAY, you can show the current title and chapter numbers for a few seconds. 	<ul style="list-style-type: none"> DVD Video:  <p>Total title no.</p>
<ul style="list-style-type: none"> DVD Audio:  <p>Current track no. Elapsed playing time</p> By pressing DISPLAY, you can show the current group and track numbers for a few seconds. 	<ul style="list-style-type: none"> DVD Audio:  <p>Total group no. Group no. Track no.</p>
<ul style="list-style-type: none"> Audio CD:  <p>Current track no. Elapsed playing time</p> 	<ul style="list-style-type: none"> Audio CD:  <p>Total track no. Total playing time</p>
<ul style="list-style-type: none"> SVCD/VCD:  <p>Current track no. Elapsed playing time*</p> * "PBC" appears while playing a disc with PBC. 	<ul style="list-style-type: none"> SVCD/VCD:  <p>Total track no.* Total playing time</p> * Changes to "PBC" when stopping PBC playback.
<ul style="list-style-type: none"> MP3/WMA:  <p>Current track no. Elapsed playing time</p> By pressing DISPLAY, you can show the current group and track numbers for a few seconds. 	<ul style="list-style-type: none"> MP3/WMA:  <p>Current track no. Current group no.</p>
<ul style="list-style-type: none"> JPEG:  <p>Current group no. Current file no.</p> 	<ul style="list-style-type: none"> JPEG:  <p>Total group no. Total file no.</p>

• If Resume is turned "ON" (see page 36), "RESUME" appears when you stop playback.

Daily Operations—Playback

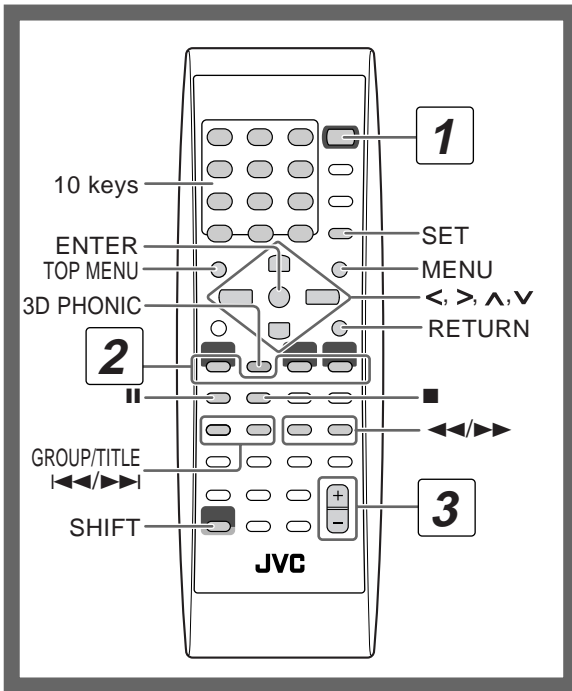

In this manual, the operation using the remote control is mainly explained; however, you can use the buttons and controls on the main unit if they have the same (or similar) name and marks.

1 Turn on the power.

The STANDBY/ON lamp on the main unit lights in green.

- Without pressing STANDBY/ON \odot/I , the System turns on by pressing one of the source selecting buttons in the next step.

2 Select the source.

Playback automatically starts if the selected source is ready to start.

- If you press AUX, start playback source on the external component.

3 Adjust the volume.

4 Operate the target source as explained later.

To turn off (stand by) the unit

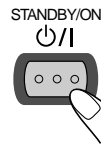

The STANDBY/ON lamp on the main unit lights in red.

- A small amount of power is always consumed even while on standby.

For private listening

Connect a pair of headphones to the PHONES jack on the main unit. The sound will no longer come out of the speakers. Be sure to turn down the volume before connecting or putting the headphones.

- Disconnecting the headphones will activate the speakers again.



DO NOT turn off (stand by) the System with the volume set to an extremely high level; Otherwise, the sudden blast of sound can damage your hearing, speakers and/or headphones when you turn on the System or start playback.

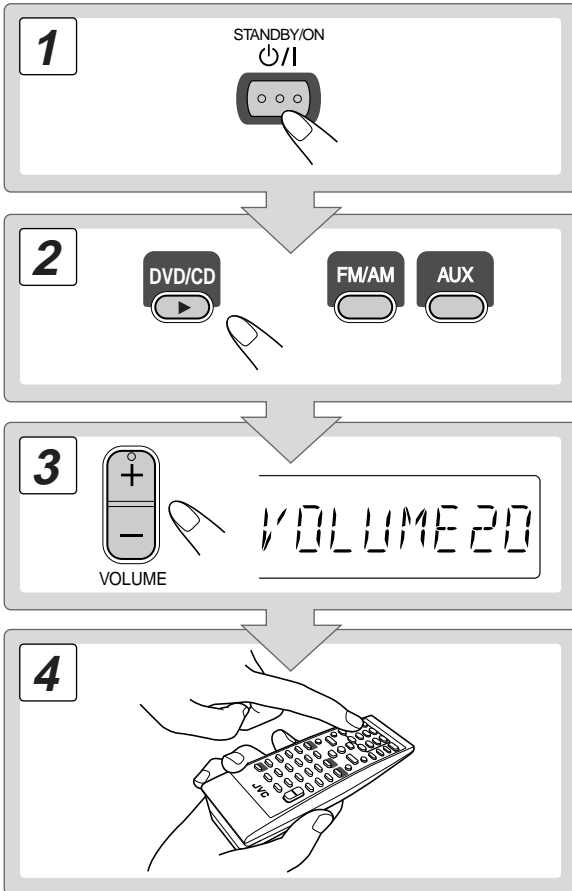

Listening to the Radio

To select the band (FM or AM)

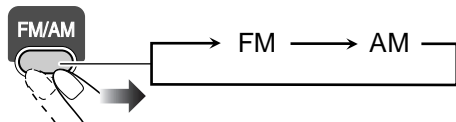

To tune in to a station

While FM or AM is selected...

Remote control:	Main unit:

Frequency starts changing on the display.

When a station (frequency) with sufficient signal strength is tuned in, the frequency stops changing.

- When you repeatedly press the button, the frequency changes step by step.

To stop searching manually, press either button.

If the received FM station is hard to listen

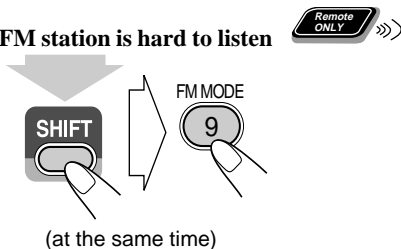

The MONO indicator lights on the display. Reception will improve though stereo effect is lost—Monaural reception mode.

To restore the stereo effect, press the button again (the MONO indicator goes off).

To preset the stations

You can preset 30 FM and 15 AM stations.

1 Tune in to a station you want to preset.

- You can also store the monaural reception mode for FM preset stations if selected.

2 Activate the preset number entry mode.



- Finish the following process while the indication on the display is flashing.

3 Select a preset number for the station you store.



Examples:

To select preset number 5, press 5.

To select preset number 15, press +10, then 5.

To select preset number 30, press +10, +10, then 10.

- You can also use the ►► or ◀◀ buttons.

4 Store the station.

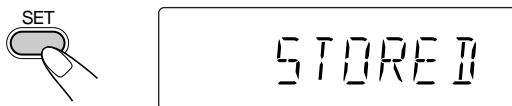

To tune in to a preset station



1 Select the band (FM or AM).

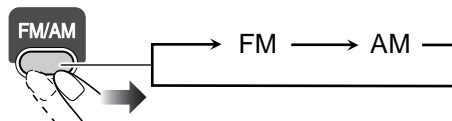

2 Select a preset number for the station you store.



- You can also use the ►► or ◀◀ buttons.

Playing Back a Disc

Before operating a disc, be familiar how a disc is recorded.

- DVD Video comprises of “Titles” which includes “Chapters,” DVD Audio/MP3/WMA/JPEG comprise of “Groups” which includes “Tracks,” and CD/SVCD/VCD comprise of only “Tracks.”
- For JPEG playback, see “Operations on the CONTROL Screen” on page 29.

To insert a disc

You can insert a disc while playing another source.

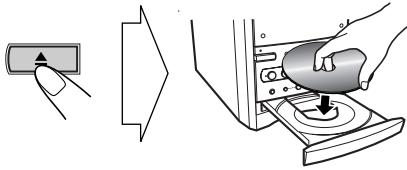

To close the disc tray, press ▲ again.

- If you press DVD/CD ►, disc tray closes automatically and playback starts (depending on how the disc is programmed internally).

To start:	To pause:	To stop:
	To release, press DVD/CD ►.	

- **While playing DVD/SVCD/VCD:** This System can store the stop point, and when you start playback again by pressing DVD/CD ► (even while on standby), it starts from the position where you have stopped—Resume Play. (“RESUME” appears on the display when you stop playback.)

To stop completely while Resume is activated, press ■ twice. (To cancel Resume, see “RESUME” on page 36.)

- When operating the System, the on-screen guide icon (see the following table) appears on the TV.

To deactivate the on-screen guide icons, see “ON SCREEN GUIDE” on page 36.

On-screen guide icons

- During DVD Video playback, the following icons may appear on the TV:

- At the beginning of a scene containing multi-angle views.
- At the beginning of a scene containing multi-audio sounds.
- At the beginning of a scene containing multi-subtitles.

- The following icons will be also shown on the TV to indicate your current operation.



To select a title/group



While playing...

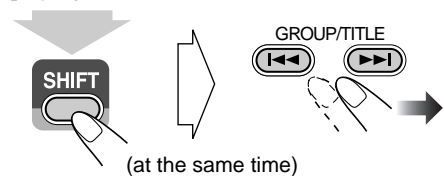

- Group name appears for MP3/WMA discs.

To select a chapter/track

While playing...

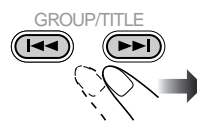

- First time you press ◀◀, you can go back to the beginning of the current chapter/track.

To locate a particular portion



While playing a disc except MP3/WMA...



- No sound comes out while searching on DVD Video/SVCD/VCD.

To return to normal playback, press DVD/CD ►.

To locate an item directly



You can select a title/chapter/track directly and start playback.

- For DVD Video, you can select a **title before starting playback**, while you can select a **chapter after starting playback**.



Examples:

- To select number 5, press 5.
- To select number 15, press +10, then 5.
- To select number 30, press +10, +10, then 10.

■ For SVCD/VCD with PBC:

While playing a disc with PBC, "PBC" appears on the display.

When disc menu appears on the TV, select an item on the menu. Playback of the selected item starts.

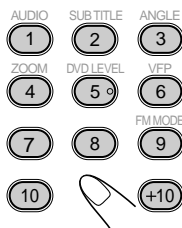

Examples:

- To select number 5, press 5.
- To select number 15, press +10, then 5.
- To select number 30, press +10, +10, then 10.

To use 3D Phonic

While playing...

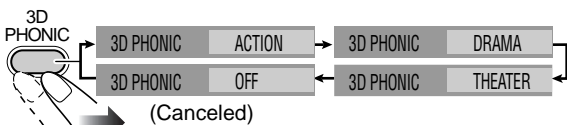

- The selected mode can only be shown on the TV.

ACTION	Suitable for action movies and sports programs.
DRAMA	Creates natural and warm sound. Enjoy movies in a relaxed mood.
THEATER	Enjoy sound effects like in a major theater.

To play back using the disc menu



■ For DVD Video/DVD Audio:

1 Show the disc menu.

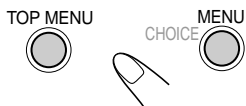

2 Select an item on the disc menu.

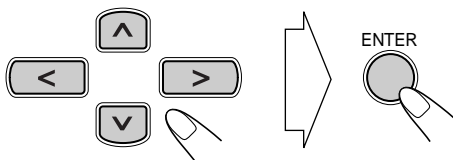

- With some discs, you can also select items by entering the number using the 10 keys.

To move to the next or previous page of the current menu:

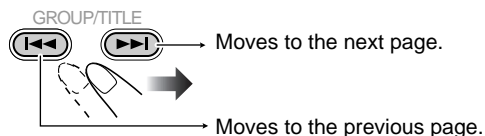

To return to the previous menu:

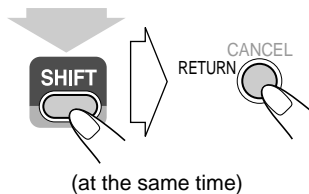

To cancel PBC

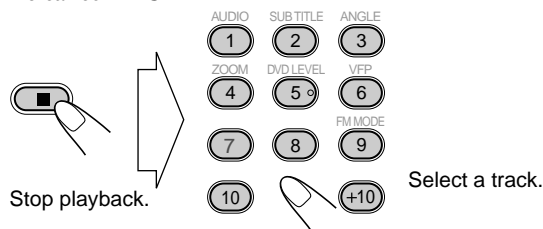

Playback starts with the selected track.

To reactivate PBC, press ■ (twice if Resume is turned "ON"), then press DVD/CD ►.

Daily Operations—Sound & Other Adjustments

Remote control

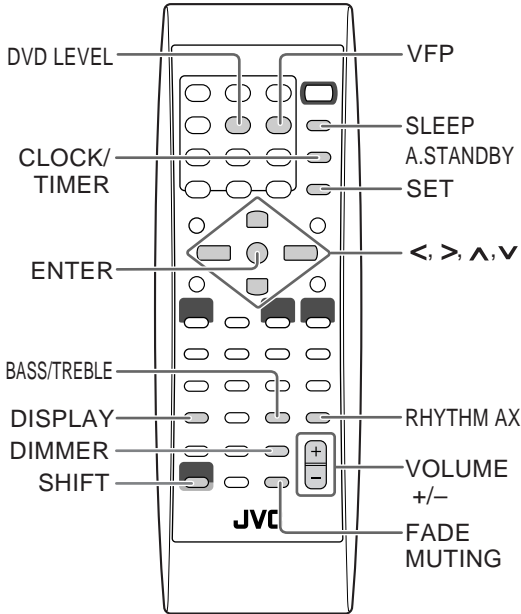

Main unit

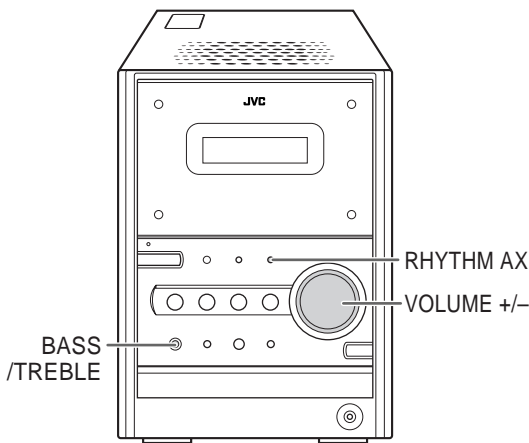

Adjusting the Volume

You can adjust the volume level from level 0 (VOL MIN) to level 50 (VOL MAX).

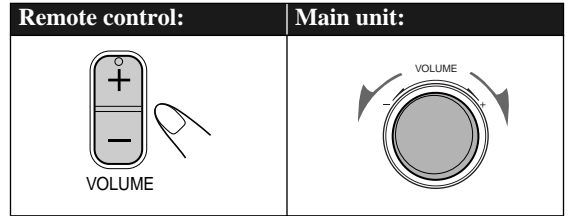

To drop the volume in a moment

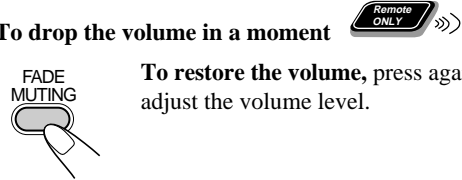

To restore the volume, press again, or adjust the volume level.

Adjusting the Sound

To emphasize rhythm feeling—RHYTHM AX

This function emphasizes bass attack feeling, and also changes the subwoofer level.

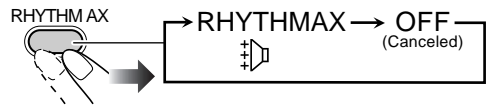

To adjust the tone

You can adjust the bass and treble level from -5 to +5.

To adjust the bass



To adjust the treble

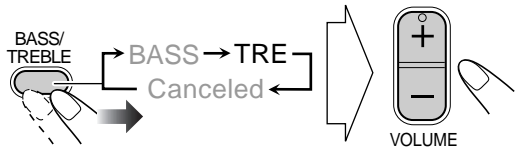

Presetting Automatic DVD Video Sound

Increase Level

The DVD Video sound is sometimes recorded at a lower level than for other discs and sources. You can set the increase level for the currently loaded DVD Video, so you do not have to adjust the volume every time you change the source.

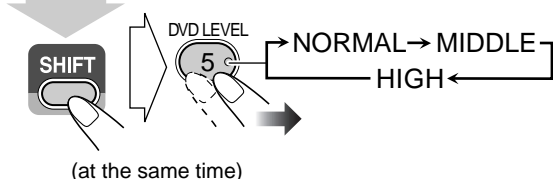

NORMAL	Original recording level.
MIDDLE	Output level is increased (less than "HIGH").
HIGH	Output level is increased (more than "MIDDLE").

- Once the current DVD is ejected, this setting is canceled and set automatically to "NORMAL."

Changing the Display Brightness

You can dim the display window.

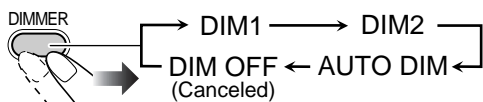

DIM1	Dims the display.
DIM2	Erases the display illumination.
AUTO DIM	Erases the display illumination when disc playback starts. <ul style="list-style-type: none"> The display illuminates when playback stops.

Changing the Picture Tone

While showing a playback picture on the TV, you can select the preset picture tone, or adjust it and store your own likeness.

To select a preset picture tone

1 While playing, display VFP setting screen.

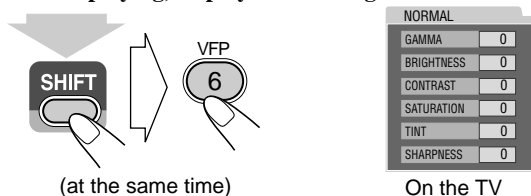

2 Select a preset picture tone.

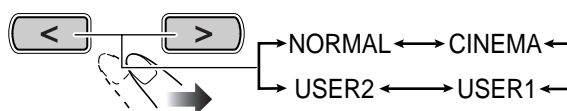

NORMAL	Normally select this.
CINEMA	Suitable for a movie source.
USER1/USER2	You can adjust parameters and can store the settings (see below).

To erase the screen, press VFP again while holding SHIFT.

To adjust the picture tone

1 Select "USER1" or "USER2."

- Follow steps 1 and 2 explained above.

2 Select a parameter you want to adjust.

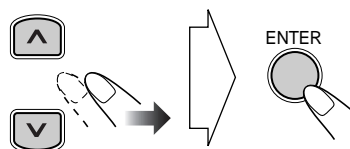

GAMMA	Adjust if the neutral color is bright or dark (-3 to +3).
BRIGHTNESS	Adjust if the entire picture is bright or dark (-8 to +8).
CONTRAST	Adjust if the far and near positions are unnatural (-7 to +7).
SATURATION	Adjust if the picture is whitish or blackish (-7 to +7).
TINT	Adjust if the human skin color is unnatural (-7 to +7).
SHARPNESS	Adjust if the picture is indistinct (-8 to +8).

3 Adjust the parameter.

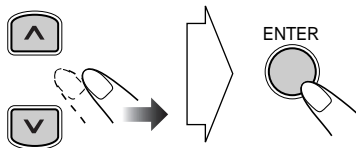

4 Repeat steps 2 to 3 to adjust other parameters.

To erase the screen, press VFP again while holding SHIFT.

Setting the Clock



Without setting the built-in clock, you cannot use Daily Timers (see page 31) and Sleep Timer.

- To correct a misentry during the process, press CANCEL or CLOCK/TIMER. You can return to the previous step.

1 Activate the clock setting mode.

CLOCK/
TIMER



- If you have already adjusted the clock before, press the button repeatedly until the clock setting mode is selected.

2 Adjust the hour.

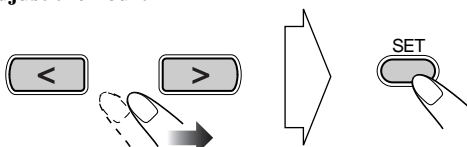

3 Adjust the minute.

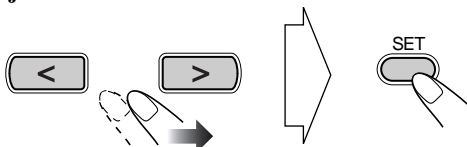

Now the built-in clock starts working.

To check the current clock time during play

DISPLAY
RDS DISPLAY

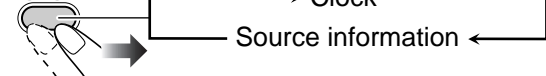

- While playing a DVD and MP3/WMA, you cannot check the current clock time (see page 9).

Turning Off the Power

Automatically



To turn off the unit after playback is over—Auto Standby

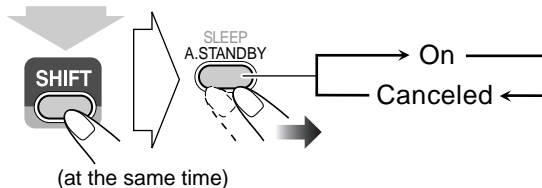

When Auto Standby is in use, the A.STANDBY indicator lights on the display.

When disc play stops, the A.STANDBY indicator starts flashing. If no operation is done for about 3 minutes while the indicator is flashing, the System turns off (stands by) automatically.

- Auto Standby does not work while you are listening to radio (TUNER) and the external component (AUX).

To turn off the unit after a certain period of time—Sleep Timer

1 Specify the time (in minutes).

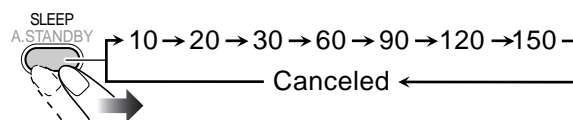

2 Wait until the set time goes off.

To check the time remaining until the shut-off time

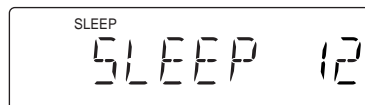

- If you press the button repeatedly, you can change the shut-off time.

Advanced Radio Operations

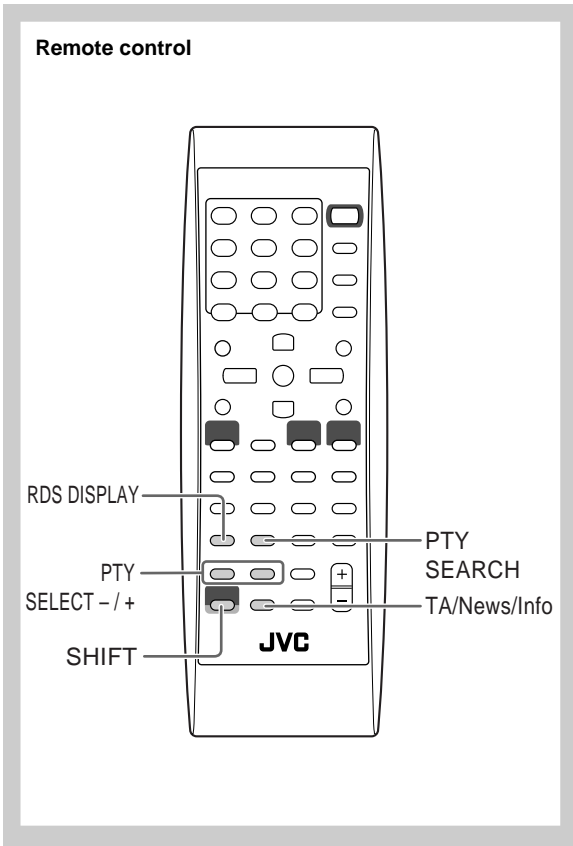

To show the RDS information

While listening to an FM station...

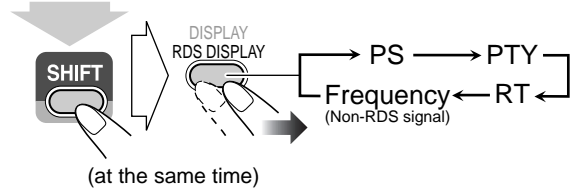

PS	Station names is displayed. "NO PS" will appear if no signal is sent.
PTY	The broadcast program type is displayed. "NO PTY" will appear if no signal is sent.
RT	Text messages the station sends is displayed. "NO RT" will appear if no signal is sent.

Searching for a Program by

PTY Codes



You can locate a particular kind of program from the preset channels (see page 11) by specifying the PTY codes.

To search for a program using the PTY codes

1 While listening to an FM station...

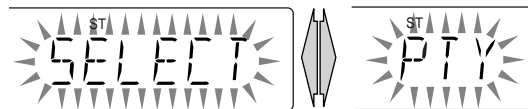
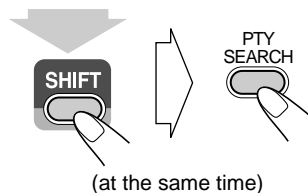

2 Select a PTY code.

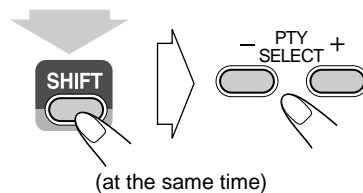

- For details about each PTY code, see page 19.

Receiving FM Stations with RDS



Radio Data System (RDS) allows FM stations to send an additional signal along with their regular program signals.

- When tuned to an FM station which provides the RDS service, the RDS indicator lights on the display.

This System can receive the following types of RDS signals.

PS (Program Service)	Shows commonly known station names.
PTY (Program Type)	Shows types of broadcast programs.
RT (Radio Text)	Shows text messages the station sends.
Enhanced Other Networks	Provides the information about the types of the programs broadcast by the RDS stations of the different networks.

3 Start searching.

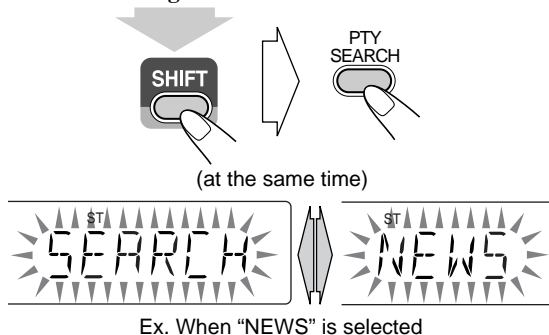

The receiver searches 30 preset FM stations, stops when it finds the one you have selected, and tunes in to that station.

- If no program is found, "NOTFOUND" appears on the display.
- To stop searching any time during search, press PTY SEARCH (while holding SHIFT).

To continue searching after it stops on an unwanted station

While the indications on the display are flashing, press PTY SEARCH again (while holding SHIFT).

Switching Temporarily to a Program of Your Choice Automatically



The Enhanced Other Networks function allows the System to switch temporarily to a preset FM station broadcasting a program of your choice (TA, NEWS, or INFO).

- This function works while listening to an FM station providing the required signals.

While listening to an FM station, select the program type.

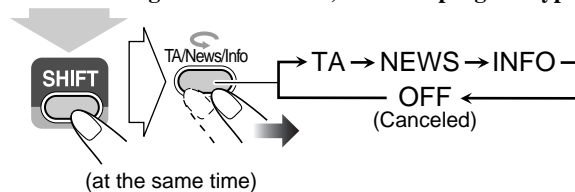

TA	Traffic announcement in your area
NEWS	News
INFO	Program the purpose of which is to impart advice in the widest sense

How the Enhanced Other Networks function actually works:

CASE 1

If a station is not broadcasting the program of your choice

The System continues tuning in to the current station.



When a station broadcasting the program of your choice, the System automatically switches to the station. The PTY code indicator starts flashing.



When the program is over, the System goes back to the previously tuned station, but the function still remains active (the indicator stops flashing and remains lit).

CASE 2

If a station is broadcasting the program of your choice

The System automatically switches to the station. The PTY code indicator starts flashing.



When the program is over, the System goes back to the previously tuned station, but the function still remains active (the indicator stops flashing and remains lit).

CASE 3

If the station currently tuned in is broadcasting the program of your choice

The PTY code indicator starts flashing.



When the program is over, the indicator stops flashing (the function still remains active).



Description of the PTY codes

NEWS	News.
AFFAIRS	Topical program expanding or enlarging upon the news—debate, or analysis.
INFO	Programs the purpose of which is to impart advice in the widest sense.
SPORT	Programs concerned with any aspect of sports.
EDUCATE	Educational programs.
DRAMA	All radio plays and serials.
CULTURE	Programs concerning any aspect of national or regional culture, including language, theater, etc.
SCIENCE	Programs about natural sciences and technology.
VARIED	Used for mainly speech-based programs such as quizzes, panel games, and personality interviews.
POP M	Commercial music of current popular appeal.
ROCK M	Rock music.
EASY M	Current contemporary music considered to be “easy-listening.”
LIGHT M	Instrumental music, and vocal or choral works.
CLASSICS	Performances of major orchestral works, symphonies, chamber music, etc.
OTHER M	Music which is not fitting into any of the other categories.
WEATHER	Weather reports and forecasts.
FINANCE	Stock market reports, commerce, trading, etc.
CHILDREN	Programs targeted at a young audience.
SOCIAL	Programs about sociology, history, geography, psychology, and society.
RELIGION	Religious programs.

PHONE IN	Involving members of the public expressing their views either by phone or at a public forum.
TRAVEL	Travel information.
LEISURE	Programs about recreational activities.
JAZZ	Jazz music.
COUNTRY	Songs which originate from, or continue the musical tradition of the American Southern States.
NATION M	Current popular music of the nation or region in that country’s language.
OLDIES	Music from the so-called “golden age” of popular music.
FOLK M	Music which has its roots in the musical culture of a particular nation.
DOCUMENT	Programs concerning factual matters, presented in an investigative style.
TEST	Broadcasts for testing emergency broadcast equipment or unit.
ALARM	Emergency announcement.
NONE	No program type, undefined program, or difficult to categorize into particular types.

Classification of the PTY codes for some FM stations may be different from the above list.

Unique DVD/VCD Operations

Remote control

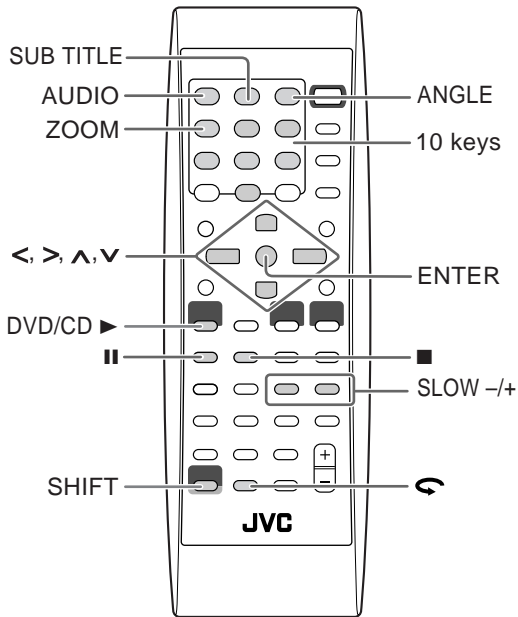

Selecting the View Angle

While playing back a chapter (of DVD Video) containing multi-view angles, you can view the same scene from different angles.

- You can also select the multi-view angles using the on-screen bar (see page 26).

While playing...

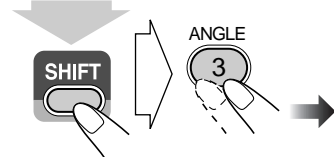

(at the same time)

Ex.:

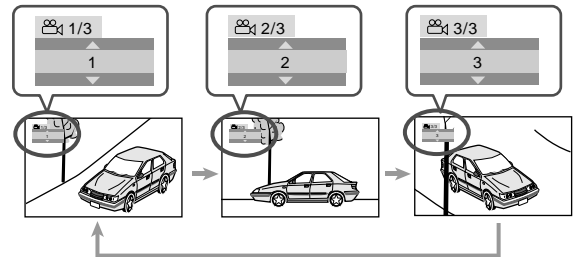

Selecting the Subtitle Language

For DVD Video: While playing back a chapter (of DVD Video) containing subtitles in different languages, you can select the subtitle language to display on the TV.

For SVCD: While playing, you can select the subtitles even if no subtitles are recorded on the disc.

- You can also select the subtitle language using the on-screen bar (see page 26).

While playing a DVD Video...

1 Display the subtitle selection window.

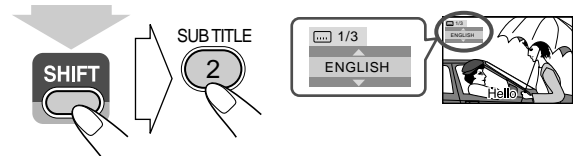

(at the same time)



2 Select the subtitle language.

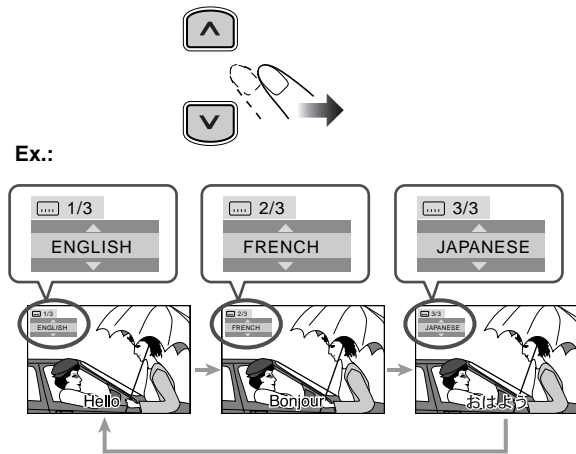

While playing an SVCD video...

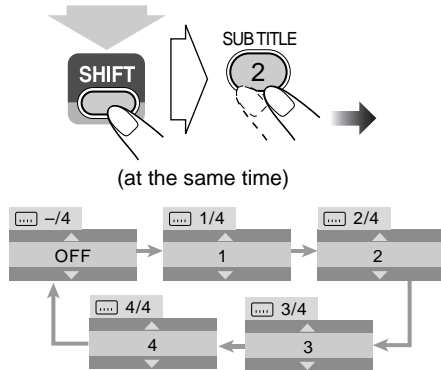

Selecting the Audio Track

- For DVD Video:** While playing back a chapter containing audio languages, you can select the language to listen to.
- For DVD Audio:** While playing back a track containing audio channels, you can select the audio channel to listen to.
- For Karaoke SVCD/VCD:** When playing back a track, you can select the audio channel to play.
- You can also select the audio track using the on-screen bar (see page 26).

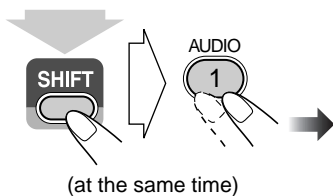

While playing a DVD video...

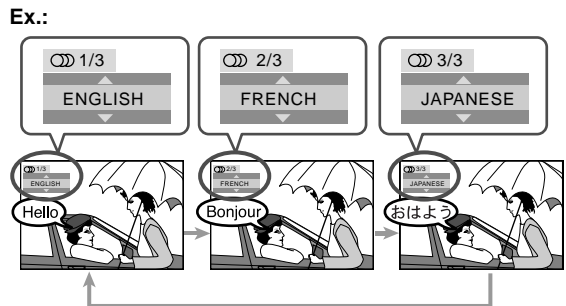

While playing a DVD Audio...



While playing a Karaoke SVCD or VCD...

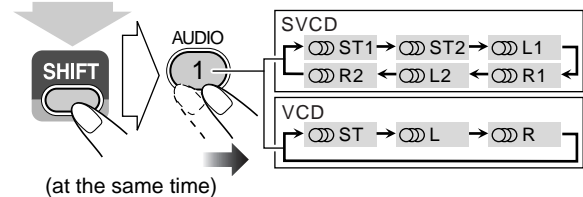

ST1/ST2 To listen to normal stereo (2 channel) playback.

L1/L2/L To listen to the left audio channel.

R1/R2/R To listen to the right audio channel.

- SVCD can have 4 audio channels. Karaoke SVCD usually uses these 4 channels to record two 2-channel recordings (ST1/ST2).

Playing Back a Bonus Group

Some DVD Audios have a special group called “bonus group” whose contents are not open to the public.

- To play back a bonus group, you have to enter the specific “key number” (a kind of password) for the bonus group. The way of getting the key number depends on the disc.

1 Select the bonus group.

- The bonus group is usually recorded as the last group (for example, if a disc contains 4 groups including a bonus group, “group 4” is the bonus group).
- For how to select the group, see “To select a title/group” on page 12.

2 Enter the key number.

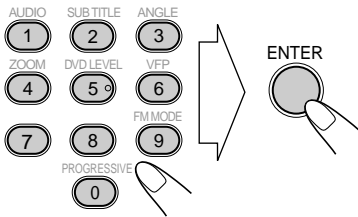

3 Follow the interactive instructions shown on the screen.

To cancel the key number entry, press ■.

2 Select slow motion speed.

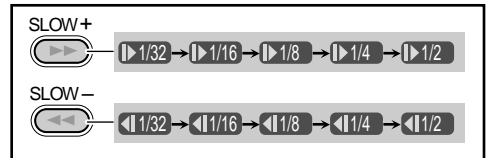
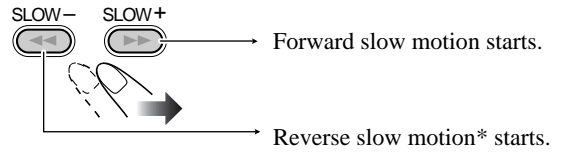

*Not available for SVCD/VCD.

Special Effect Playback

Still picture playback.

To start still picture playback:	To resume normal playback:
While playing... 	

To resume normal playback, press DVD/CD ►.

To replay the previous scenes (One-Touch Replay)

• This function is only used while playing DVD Video.

While playing back...



The playback position moves back about 10 seconds before the current position (only within the same title).

Frame-by-frame playback

1 While playing...



Still picture playback starts.

2 Advance the still picture frame by frame.



To resume normal playback, press DVD/CD ►.

Slow-motion playback

1 While playing...



Still picture playback starts.

Zoom

1 While playing back...

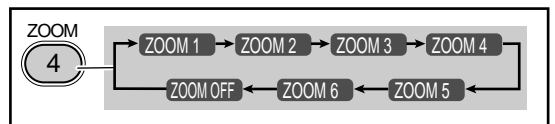
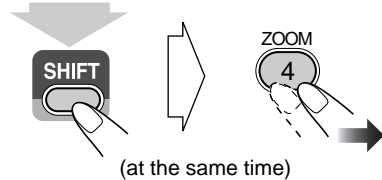

2 Move the zoomed-in position.

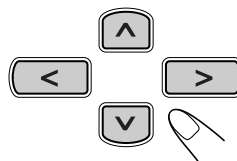

To cancel Zoom, press ZOOM repeatedly (while holding SHIFT) until "ZOOM OFF" appears on the TV.

Advanced Disc Operations

Remote control

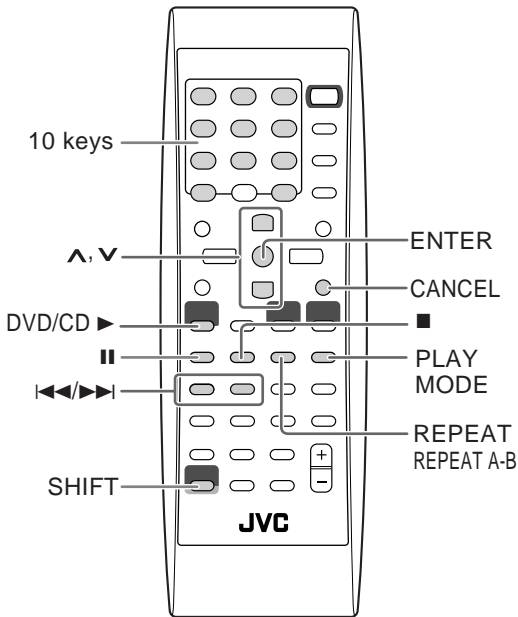

Main unit

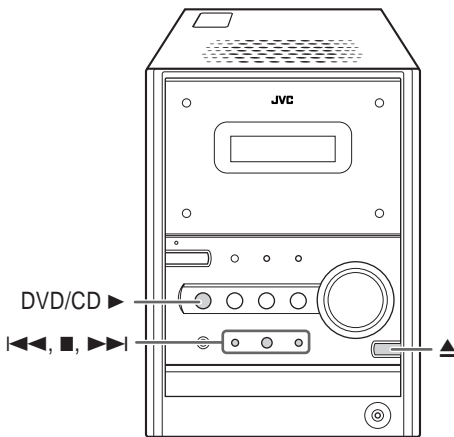

Programming the Playing Order

Program Play

You can arrange the playing order of the chapters or tracks (up to 99) before you start playback.

1 Before starting playback, activate Program Play.

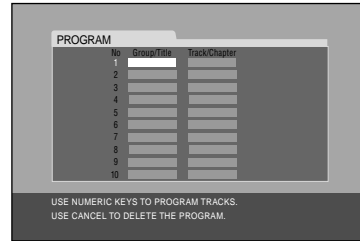
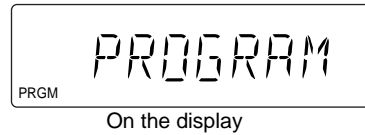
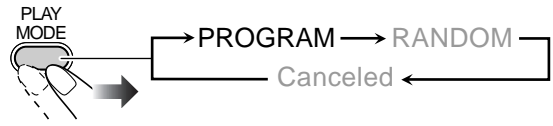

On the TV

2 Select chapters or tracks you want for Program Play.

• For DVD/MP3/WMA:

- ① Select a title or group number.
- ② Select a chapter or track number.
- ③ Repeat the above steps ① and ②.

• For SVCD/VCD/CD:

- ① Select tracks.

To enter the numbers directly:

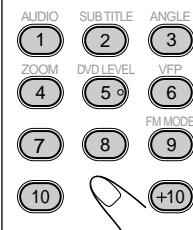

Examples:

To enter number 5, press 5.
To enter number 15, press +10, then 5.

To enter number 30, press +10, +10, then 10.

3 Start playback.



Playback starts in the order you have programmed.

To skip a step:	To pause:	To stop:
<p>GROUP/TITLE</p>	<p>To release, press DVD/CD ►.</p>	

To check the programmed contents

Before or after playback...



In the reverse order.



In the programmed order.

- You can also use ◀◀ or ▶▶ to check the programmed contents.

To modify the program

Before or after playback...

To erase the last step:	To erase the entire program:
To add steps in the program: Repeat step 2.	

To exit from Program Play

Before or after playback...



Playing at Random—Random Play

You can play all chapters or tracks at random.

- Random Play cannot be used for some DVDs.

1 Before starting playback, activate Random Play.

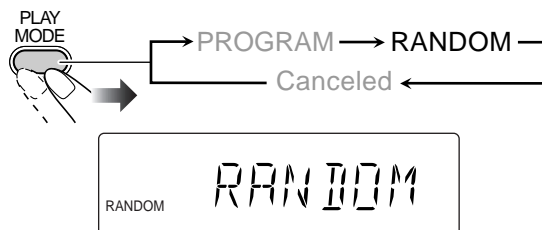

2 Start playback.



Playback starts in random order. Random Play ends when the entire disc has been played.

To skip a chapter/track:	To pause:	To stop:
	<p>To release, press DVD/CD ►.</p>	

To exit from Random Play

Before or after playback...



Playing Repeatedly

- You can also select the repeat mode using the on-screen bar (see page 27).

Repeat Play

You can repeat playback.

• For DVD Video:

While playing...

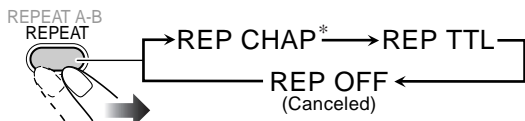

• For DVD Audio:

While playing or before playback...

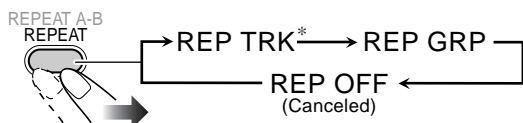

• For MP3/WMA:

While playing or before playback...

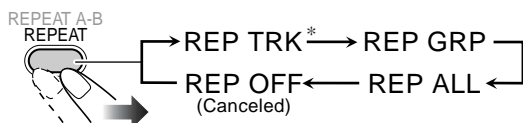

• For CD/SVCD/VCD:

While playing (without PBC for SVCD/VCD) or before playback...

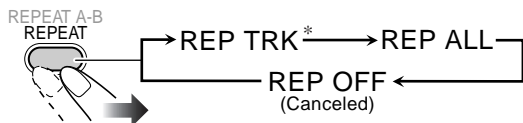

REP CHAP* Repeats the current chapter.

REP TTL Repeats the current title.

REP TRK* Repeats the current track.

REP GRP Repeats the current group.

REP ALL Repeats the disc or program.

*During Program Play and Random Play, "REP STEP" appears instead of these indications, and repeat modes change as follows for all the discs.

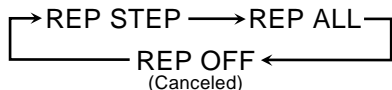

A-B Repeat

You can repeat playback of a desired portion by specifying the beginning (point A) and the ending (point B).

- A-B Repeat cannot be used for MP3/WMA and for some DVDs.
- A-B Repeat can be used within the same title while playing a DVD Video, and within the same track for the other discs.

1 While playing (without PBC for SVCD/VCD), select the start point (A).

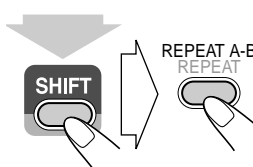

(at the same time)

starts flashing on the display.

-  A-B appears on the TV if the TV is turned on.

2 Select the end point (B).

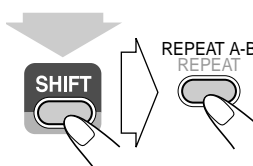

(at the same time)

stops flashing.

-  A-B appears on the TV.

- You can search for the end point using the ►► button.

To cancel A-B Repeat, press REPEAT A-B again while holding SHIFT.

- A-B Repeat will also be canceled when you stop play or skip the chapter or track.

Prohibiting Disc Ejection—Child Lock

You can lock the disc tray so that no one can eject the loaded disc.

- This is possible while the System is on standby.

While the disc tray is closed...

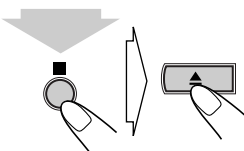

(at the same time)

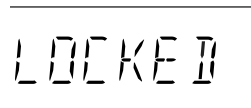

To cancel the prohibition, repeat the same procedure.

"UNLOCKED" appears on the display.

On-Screen Disc Operations

Remote control

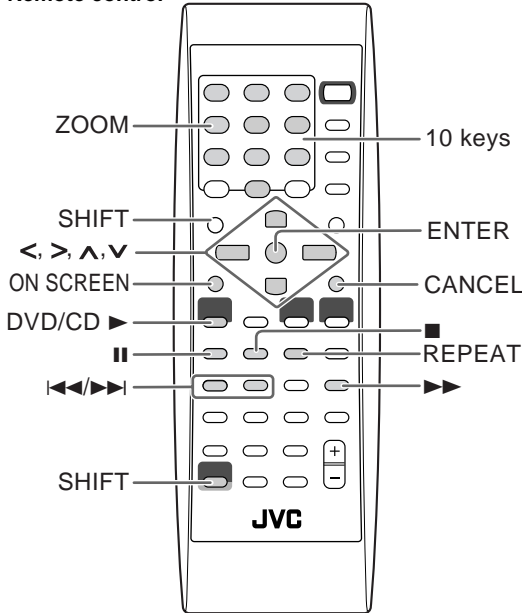

On-screen bars

DVD Video

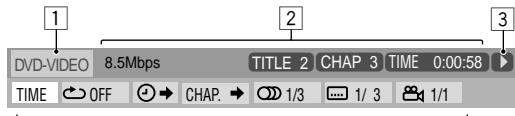

DVD Audio

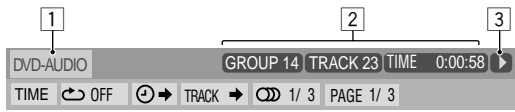

SVCD

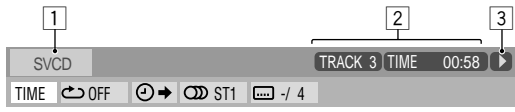

VCD

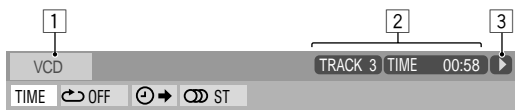

CD



On-screen Bar Information

You can check the disc information (except for MP3/WMA/JPEG disc) and use some functions through the on-screen bar.

1 Disc type

2 Playback information

Indication	Meanings
Mbps	Current transfer rate (Megabits per second)
TITLE 2	Current title
CHAP 3	Current chapter
GROUP 1	Current group
TRACK 14	Current track
TOTAL 1:25:58	Time indications

3 Operation modes

Indication	Meanings
▶	Playback
▶▶ / ◀◀	Forward/Reverse search
▶ / ◀	Forward/Reverse slow-motion
	Pause
■	Stop

4 Function icons (on the pull-down menu)

Indication	Meanings
TIME	Select to change the time indication.
OFF	Select to repeat playback.
↻	Select for time search.
CHAP. →	Select for chapter search.
TRACK →	Select for track search.
1/3	Select to change the audio language or channel (see also page 21).
1/3	Select to change subtitle language (see also page 20).
1/3	Select to change the view angle (see also page 20).
PAGE 1/5	Select to change the page.

Operations Using the On-screen Bar

Ex.: Selecting a subtitle (French) for DVD Video

While a disc is selected as the source...

1 Display the on-screen bar with the pull-down menu.

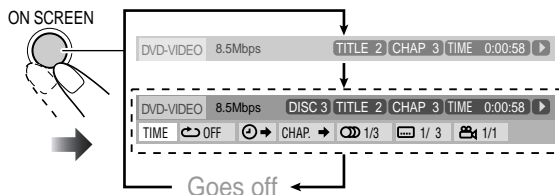

2 Select (highlight) the item you want.

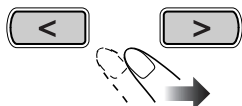

3 Display the pop-up window.



4 Select the desired option in the pop-up window.

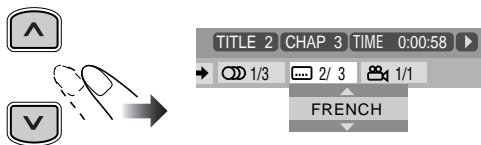

5 Finish the setting.

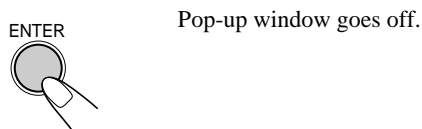

To erase the on-screen bar



For detailed operations of the following functions, see also “Operations Using the On-screen Bar” on the left.

To change the time information

You can change the time information in the on-screen bar and the display window on the main unit.

1 While playing, display the on-screen bar with the pull-down menu.



2 Make sure [TIME] is selected (highlighted).

3 Change the time indication.

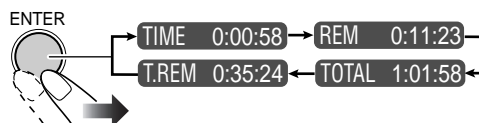

TIME	Elapsed playing time of the current chapter/track.
-------------	--

REM	Remaining time of the current chapter/track.
------------	--

TOTAL	Elapsed disc time.
--------------	--------------------

T.REM	Remaining disc time.
--------------	----------------------

To erase the on-screen bar



Repeat Play

• See also page 25.

1 While playing a disc (without PBC for SVCD/VCD), display the on-screen bar with the pull-down menu.

• Except for DVD Video: Repeat Play can be selected before starting playback.

2 Select [OFF].

3 Display the pop-up window.



4 Select the repeat mode you want.

A-B	Repeats a desired portion (see below).
TITLE	Repeats the current title.
GROUP	Repeats the current group.
ALL	Repeats the disc (except for DVD) or program.
CHAPTER*	Repeats the current chapter.
TRACK*	Repeats the current track.
OFF	Cancels Repeat Play.

* During Program Play and Random Play, "STEP" appears.

5 Finish the setting.



A-B Repeat

• See also page 25.

1 While playing, display the on-screen bar with the pull-down menu.

2 Select [OFF].

3 Display the pop-up window.



4 Select "A-B."

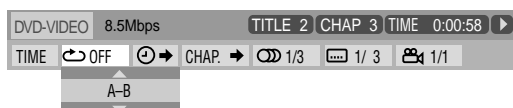

5 Select the start point (A).



6 Select the end point (B).



A-B Repeat starts. The selected portion plays repeatedly.

- Before pressing ENTER, you can search for the end point using the ►► button.

To cancel A-B Repeat, repeat steps 1 to 3, and select "OFF" in step 4.

Time Search

You can move to a particular point by specifying the elapsed playing time from the beginning.

1 While playing (without PBC for SVCD/VCD), display the on-screen bar with the pull-down menu.

- Except for DVD: Time Search can be used before starting playback.

2 Select [TIME].

3 Display the pop-up window.



4 Enter the time.

You can specify the time in hours/minutes/seconds.

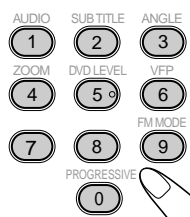

Examples:

To move to a point of 1 (hours): 02 (minutes): 00 (seconds), press 1, 0, 2, 0, then 0.

To move to a point of 54 (minutes): 00 (seconds), press 0, 5, 4, 0, then 0.

- It is always required to enter the hour digit (even "0" hour), but it is not required to enter trailing zeros (the last two digits in the examples above).

- **To correct a misentry**, press Cursor < to erase the last entry.

5 Finish the setting.



The System starts playing the disc from the selected playing time.

Chapter/Track Search

You can search for the chapter (DVD Video) or track (DVD Audio) number to play.

1 While playing, display the on-screen bar with the pull-down menu.

2 Select [CHAP.] or [TRACK].

3 Display the pop-up window.



4 Enter the desired chapter/track number.



Examples:

To select chapter/track 5, press 5.

To select chapter/track 15, press 1, then 5.

To select chapter/track 30, press 3, then 0.

- To correct a misentry, press the 10 keys until the desired number shown in the pop-up window.

5 Finish the setting.



The System starts playing the searched chapter or track.

Selecting Browsable Still Pictures

While playing back a track (of DVD Audio) linked to browsable still pictures (BSP), you can select the still picture (turn the page) to be shown on the TV.

- If a track is linked to browsable still pictures (BSP), they are usually shown in turn automatically during playback.

1 While playing a DVD Audio, display the on-screen bar with the pull-down menu.

2 Select PAGE 1 / 5 .

3 Display the pop-up window.

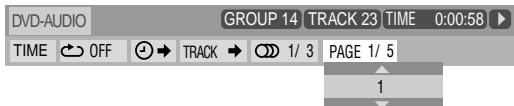

4 Select a still picture you want.

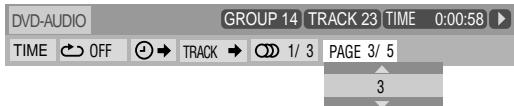

5 Finish the setting.



Operations on the CONTROL Screen

The CONTROL screen automatically appears on the TV when you load an MP3, WMA, or JPEG disc.

You can search for and play the desired tracks through the CONTROL screen.

- If both types of files (MP3/WMA files and JPEG files) are recorded on a disc, select the file type to play (see page 35).

CONTROL screen

Ex.: When the MP3 disc is loaded.

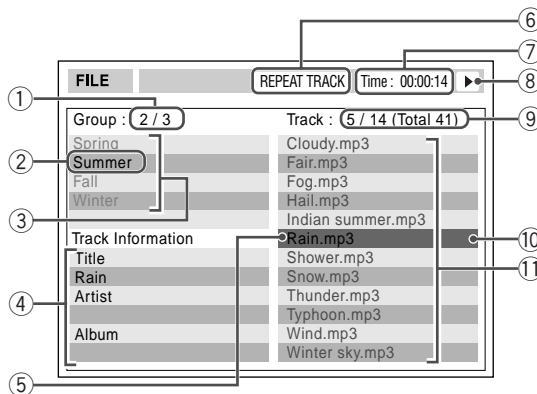

- 1 Current group number/total group number
- 2 Current group (in blue)
- 3 Group list
- 4 Track information (ID3 Tag Version 1.0: only for MP3/WMA)
- 5 Current track (in blue)
- 6 Repeat Play setting
- 7 Elapsed playing time of the current track (only for MP3/WMA)
- 8 Operation mode icon
- 9 Current track number/total number of tracks in the current group (total number of tracks on the loaded disc)
- 10 Highlight (green) bar
- 11 Track list

To move the highlight (green) bar between group list and track list:

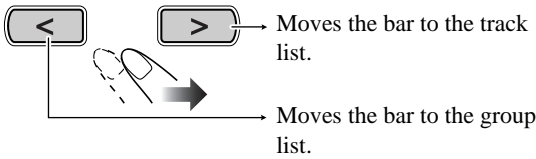

To select a group/track in the list:

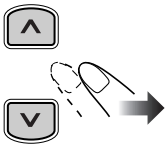

Move the highlight bar to a desired item.
 • If you move the highlight bar while playing back an MP3/WMA disc, the selected track starts playback automatically.

To start playback

For MP3/WMA:	
	Playback starts with the selected track. • Pressing DVD/CD ► also starts playback.
For JPEG:	
	The selected track (still picture) is displayed until you change it.
	Slide-show playback starts. Each track (still picture) is shown on the screen for about 3 seconds, then changes one after another.

- Once you start playing back a JPEG track, the CONTROL screen goes off.
- To cancel slide-show, and display the current still picture, press II.

To skip a track:	To stop playback:

To repeat slide-show for JPEG

While playing or before starting playback...

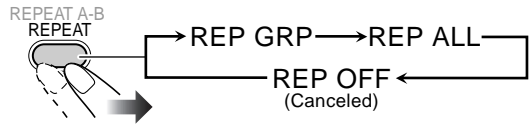

REP GRP Repeats the current group.

REP ALL Repeats the disc.

- For Repeat Play of MP3/WMA, see page 25.

To zoom in the still picture

- You cannot zoom in the still picture during slide-show.

1 While playing back...

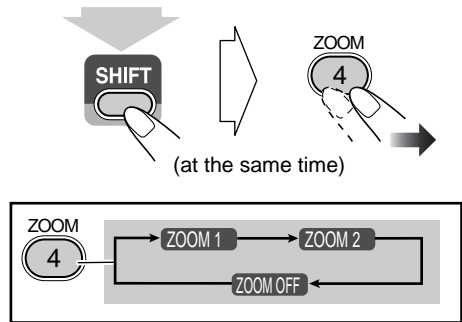

2 Move the zoomed-in position.

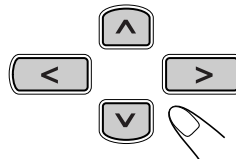

To cancel Zoom, press ZOOM repeatedly (while holding SHIFT) until "ZOOM OFF" appears on the TV.

Timer Operations

Remote control

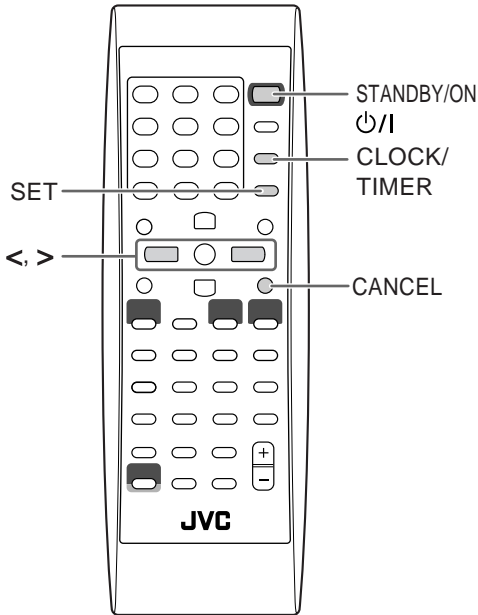

Main unit

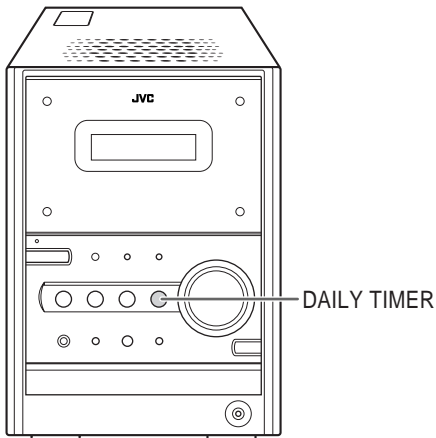

Setting the Timer



Using Daily Timer, you can wake up with your favorite music.

You can store three Daily Timer settings; however, you can activate only one of the timers at a time.

- To exit from the timer setting, press **CLOCK/TIMER** as required.
- To correct a misentry during process, press **CANCEL**. You can go back to the previous step.

Daily Timer initial settings when shipped from the factory

- DAILY 1: ON Time (6:00)/OFF Time (8:00)/ Source (TUNER FM 1)/Volume level (--)
- DAILY 2: ON Time (12:00)/OFF Time (14:00)/ Source (TUNER FM 1)/Volume level (--)
- DAILY 3: ON Time (18:00)/OFF Time (20:00)/ Source (TUNER FM 1)/Volume level (--)

- 1 Select one of the timer setting modes you want to set— Daily 1 ON time, Daily 2 ON time, or Daily 3 ON time.**

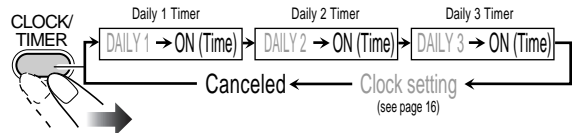

Ex. When Daily Timer 1 setting mode is selected.

- When the clock has not been adjusted, pressing **CLOCK/TIMER** makes the System enter the clock setting mode.

- 2 Make the timer setting as you want.**

Repeat the following operations until you finish setting in the following order—

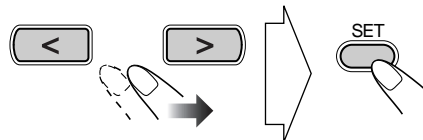

- 1 Set the hour then the minute for on-time.**

- ② Set the hour then the minute for off-time.
- ③ Select the playback source—"TUNER FM," "TUNER AM," "DISC," or "AUX."



- ④ For "TUNER FM" and "TUNER AM": Select a preset channel.
For "DISC": Select the title/group number, then the chapter/track number.
- ⑤ Select the volume level.
 - You can select the volume level ("VOL 0" to "VOL 50" and "VOL --").
 - If you select "VOL --," the volume is set to the last level when the unit has been turned off.

Once settings are complete, the Timer setting information appears in sequence.

- ③ Turn off the unit (on standby) if you have set the timer with the System turned on.

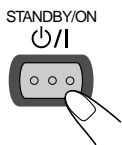

How Daily Timer actually works

Once the Daily Timer has been set, the timer (☺) indicator and timer number indicator (1/2/3) are lit on the display. Daily Timer is activated at the same time everyday until the timer is turned off manually (see the next column) or another timer is activated.

When the on-time comes

The System turns on, tunes in to the specified station or start playing the loaded disc with the specified chapter or track, and sets the volume level to the preset level.

- While Daily Timer is working, the timer (☺) indicator and timer number indicator (1/2/3) flash on the display.

When the off-time comes

The System stops playback, and turns off (stands by) automatically.

- The timer setting remains in memory until you change it.

To turn on or off the Timer

Since Daily Timer is activated at the same time everyday, you may need to cancel it on some particular days.

- 1 Select the Timer you want to activate (or select "DLY OFF" to cancel the Timer).

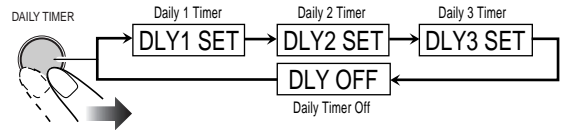

- 2 Wait until the indication goes off.

Timer setting information appears in sequence.

- If you set the Timer with the System turned on, do not forget to turn off the System after use.

When using the remote control:

To cancel the Timer

- 1 Select the Timer you want to cancel.

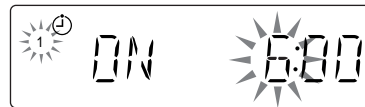
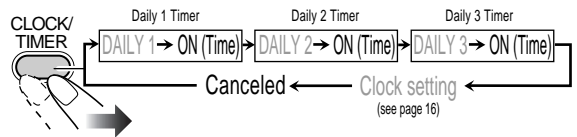

Ex. To cancel Daily Timer 1

- 2 Turn off the selected Timer.



To turn on the Timer

- 1 Select the Timer (DAILY 1, DAILY 2, or DAILY 3) you want to activate.

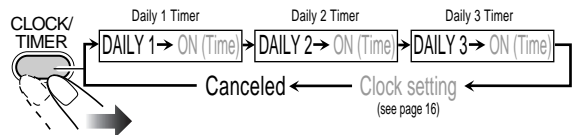

- 2 Activate the selected Timer.

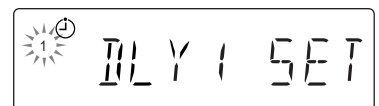
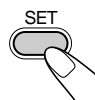

Ex. When Daily Timer 1 (DAILY 1) is activated

- 3 Wait until the indication goes off.

Setup Menu Operations

Remote control

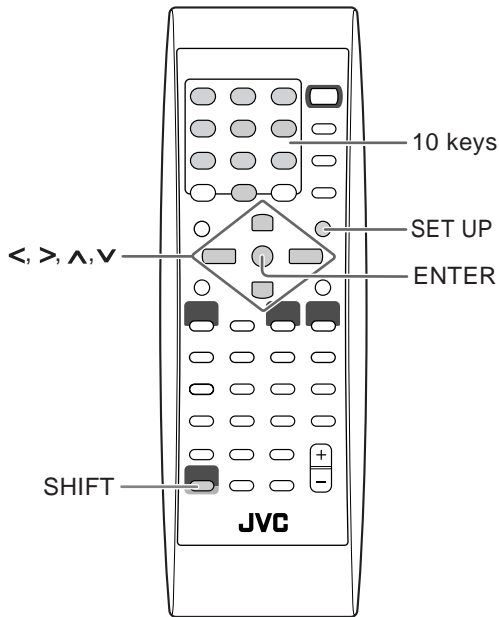

Setup Menu Icons

The icon for the selected Setup Menu will be highlighted.

Ex.: LANGUAGE Setup Menu is selected.

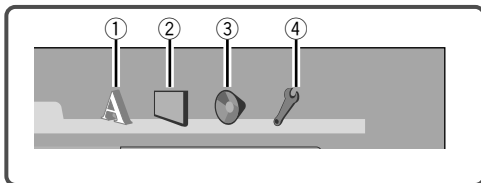

- ① LANGUAGE Setup Menu
- ② PICTURE Setup Menu
- ③ AUDIO Setup Menu
- ④ OTHERS Setup Menu

Operating Procedure

Remote ONLY

You can use the Setup Menus only when a disc is selected as the source and its playback is not yet started.

Ex.: Selecting "STILL PICTURE" for "FILE TYPE":

1 Display the Setup Menu.

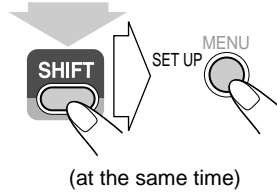

2 Select one of the Setup Menus.

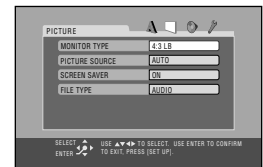
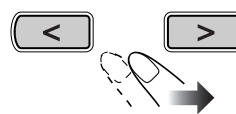

3 Select the item you want to adjust.

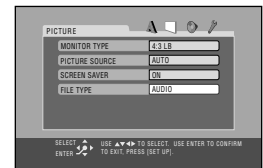
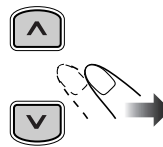

4 Display the pop-up window.

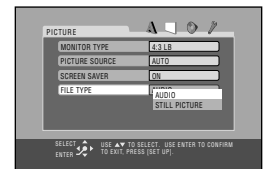

5 Select the desired option in the pop-up window.

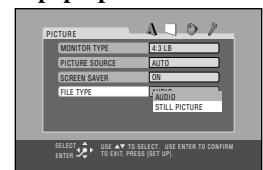
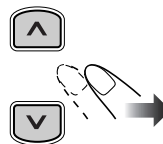

6 Finish the setting.



- 7 Repeat steps 3 to 4 to set other items on the same Setup Menu.**
Repeat steps 2 to 4 to set other items on another Setup Menu.

To exit from the Setup Menu

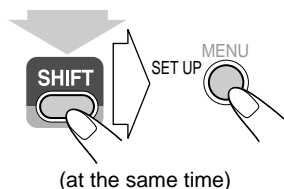

(at the same time)

LANGUAGE Setup Menu

You can select the initial languages for disc playback. You can also select the language shown on the TV screen while operating this System.

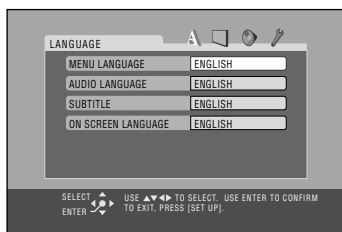

MENU LANGUAGE

Some discs have multiple menu languages. Select from—ENGLISH, SPANISH, FRENCH, CHINESE, GERMAN, ITALIAN, JAPANESE, AA – ZU (see “Language Code List” on page 42).

AUDIO LANGUAGE

Some discs have multiple audio languages. Select from—ENGLISH, SPANISH, FRENCH, CHINESE, GERMAN, ITALIAN, JAPANESE, AA – ZU (see “Language Code List” on page 42).

SUBTITLE

Some discs have multiple subtitle languages. Select from—ENGLISH, SPANISH, FRENCH, CHINESE, GERMAN, ITALIAN, JAPANESE, AA – ZU (see “Language Code List” on page 42) or “OFF (no subtitle).”

ON SCREEN LANGUAGE

Select one of the languages shown on the TV from—ENGLISH, FRENCH, and GERMAN.

PICTURE Setup Menu

You can select the desired options concerning a picture or monitor screen.

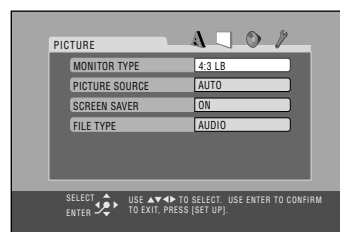

MONITOR TYPE

Select the monitor type of your TV to play DVD Video recorded with aspect ratio of 16:9.

Select one of the following:

16:9:

Select when the aspect ratio of your TV is 16:9 (wide TV).

4:3 LB (Letter Box):

Select when the aspect ratio of your TV is 4:3 (conventional TV). While viewing a wide screen picture, the black bars appear on the top and the bottom of the screen.

4:3 PS (Pan Scan):

Select when the aspect ratio of your TV is 4:3. While viewing a wide screen picture, the black bars do not appear; however, the left and right edges of the pictures will not be shown on the screen.

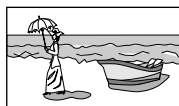

Ex.: 16:9

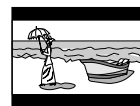

Ex.: 4:3 LB

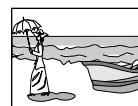

Ex.: 4:3 PS

PICTURE SOURCE

You can obtain optimal picture quality by selecting an appropriate option—picture source type (either video source or film source).

Select one of the following:

AUTO: Normally select this.
When playing back a disc containing both video and film sources, the System automatically changes the processing to match it to the picture type (film or video source) of the current chapter.

FILM: To play a film source disc.

VIDEO: To play a video source disc.

SCREEN SAVER

You can activate or deactivate screen saver while operating the built-in disc player.

Select one of the following:

ON: The pictures on the TV becomes dark when no operation is done for about 5 minutes.

OFF: To cancel the screen saver.

FILE TYPE

If both audio tracks (MP3 or WMA files) and still picture (JPEG files) are recorded on a disc, you can select which to play.

Select one of the following:

AUDIO: To play MP3/WMA files.

STILL PICTURE: To play JPEG files.

AUDIO Setup Menu

You can adjust the sound settings of the System.

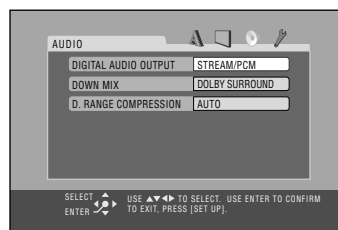

DIGITAL AUDIO OUTPUT

When using the digital output terminal on the rear, set this correctly according to the connected component.

Select one of the following:

PCM ONLY: To connect to a linear PCM digital equipment such as an MD recorder.

DOLBY DIGITAL /PCM: To connect to a Dolby Digital decoder or an amplifier with a built-in Dolby Digital decoder.

STREAM/PCM: To connect to a DTS decoder or an amplifier with a built-in DTS decoder.

- See also “DVD OPTICAL DIGITAL OUT Signals” on page 44.

DOWN MIX

When playing a multi-channel DVD, the System converts the signals into 2 channels.

Downmix setting is effective for the speaker output (and digital audio output if “DIGITAL AUDIO OUTPUT” is set to “PCM ONLY”) from this System.

Select one of the following:

DOLBY SURROUND: To connect an amplifier with the Dolby Pro Logic decoder.

STEREO: To connect a conventional stereo amplifier, receiver, MD player, TV, etc.

D. RANGE COMPRESSION

You can compress the dynamic range (the difference between the loudest sound and the softest sound) to enjoy a powerful sound even at a low volume level when listening to Dolby Digital software. This is useful at night.

- The effectiveness varies depending on a software.

Select one of the following:

AUTO: To enjoy powerful sounds with full dynamic range.

ON: Best for watching a movie at a low volume level.

OTHERS Setup Menu

You can change some other convenient functions.

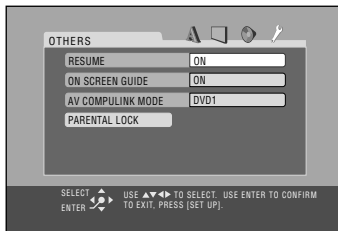

RESUME

You can activate or deactivate Resume for disc playback (see page 12).

Select one of the following:

ON: To activate Resume.

OFF: To cancel Resume.

ON SCREEN GUIDE

You can activate or deactivate the on-screen guide icons (see page 12).

- When recording the picture on a VCR, select "OFF" to avoid recording the guide icons on your video tape.

Select one of the following:

ON: To activate the on-screen guide icons.

OFF: To cancel the on-screen guide icons.

AV COMPU LINK MODE

This function is equipped for future use.

Keep this setting to the initial setting (**DVD1**) for this System.

PARENTAL LOCK

Select this to enter the PARENTAL LOCK submenu.

See the section that follows.

Restricting the Review

Parental Lock

You can restrict playback of DVD Video containing violent scenes and those unsuitable for your family members. Once you have set the rating level, such violent scenes (for which a higher level than you set is assigned) may be skipped or changed to another scene (depending on how the disc is programmed).

To set Parental Lock

Set the rating level—Level 1 (most restrictive) to Level 8 (least restrictive).

1 Display the Setup Menu.

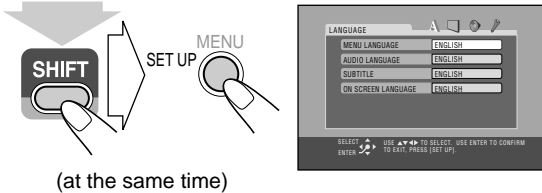

2 Select the OTHERS Setup Menus.

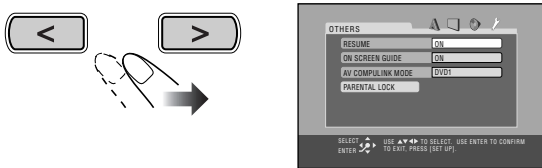

3 Select "PARENTAL LOCK."

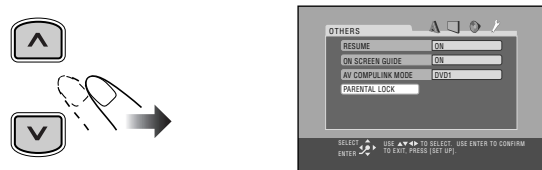

4 Enter the PARENTAL LOCK submenu.

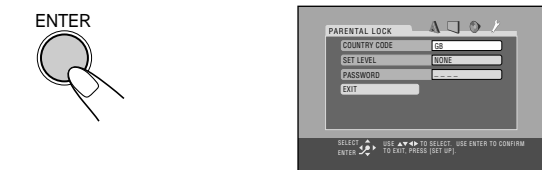

5 Select "COUNTRY CODE," then display the pop-up window.

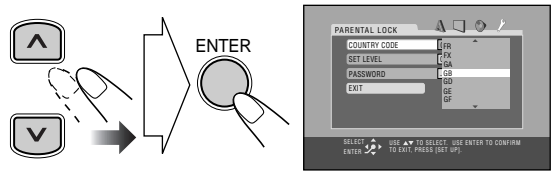

6 Select the country code of your area.

- See "Country/Area Codes List" on page 43 to find your country code.

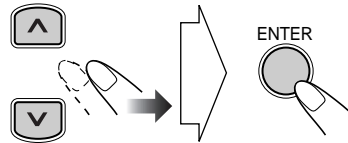

The System automatically enters "SET LEVEL" mode.

7 Make sure "SET LEVEL" is selected, then display the pop-up window.

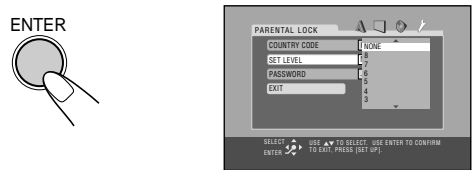

8 Set the rating level (NONE, 8 – 1).

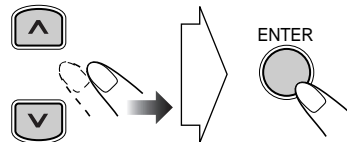

The System automatically enters "PASSWORD" entry mode.

9 Make sure "PASSWORD" is selected, then enter any 4-digit number for your password.

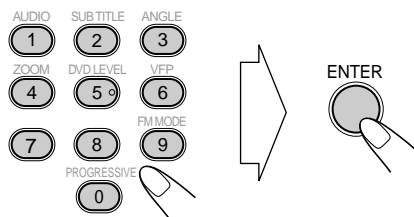

10 Finish the setting.



To change the setting

1 Display the PARENTAL LOCK submenu.

- Follow steps **1** to **4** of “To set Parental Lock.”



“PASSWORD” is automatically selected.

- You cannot select any item other than “EXIT” until you enter the correct password.

2 Enter your password.

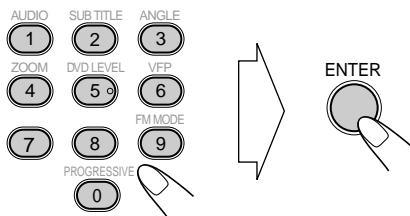

- If you enter a wrong password, “----” appears again. If you missed three times, “EXIT” is automatically selected. In this case, press ENTER to exit from the PARENTAL LOCK submenu.
- If you forget your password, enter “8888.”

3 Change the settings.

- Follow steps **5** to **8** of “To set Parental Lock.”

4 Enter your password again (after selecting “PASSWORD” manually if necessary).

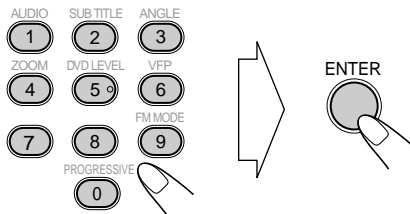

- If you want to change a password, enter a new four digit number in this step.

To release Parental Lock temporarily

When you set a strict rating level, some discs may not be played back at all. When you try to play such a disc, the following screen appears on the TV.



1 Select “TEMPORARY RELEASE,” then ENTER.

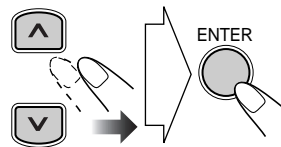

“PASSWORD” is automatically selected.

- If you do not play back such a disc, select “NOT RELEASE,” then ENTER. Then eject the disc.

2 Enter your password.

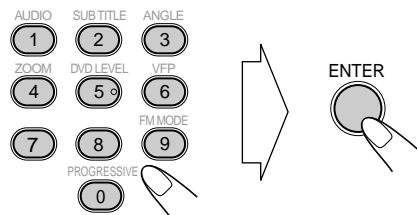

- If you enter a wrong password three times, “NOT RELEASE” is automatically selected. In this case, press ENTER. Then eject the disc.

Additional Information

Learning More about This System ● ● ●

Daily Operations—Playback (see pages 10 to 13)

Listening to the Radio:

- If you store a new station into an occupied preset number, the previously stored station in that number will be erased.
- When you unplug the AC power cord or if a power failure occurs, the preset stations will be erased in a few days. If this happens, preset the stations again.

Playing Back a Disc:

- When using an 8 cm disc, place it on the inner circle of the disc tray.
- On some DVD, SVCD, or VCD discs, the actual operations may be different from what is explained in this manual, due to the programming and disc structure; such differences are not a malfunction of this System.
- Some DVD Audio discs prohibit downmixed output. When you play back such a disc, “LR ONLY” appears on the display and the System plays back the left front and right front signals.
- 3D Phonic setting is also applied to the optical digital output signals through the DVD OPTICAL DIGITAL OUT terminal.
- When using Resume on SVCD or VCD with PBC, the playback might start on a position slightly different from where you have stopped.
- You can use Resume only for the DVD/SVCD/VCD except for some discs—depending how the disc is programmed.
- For MP3/WMA playback...
 - This System cannot play “packet write” discs.
 - MP3/WMA discs are required a longer readout time than regular CDs. (It depends on the complexity of the group/file configuration.)
 - Some MP3/WMA files cannot be played back and will be skipped. This result from their recording processes and conditions.
 - When making MP3/WMA discs, use ISO 9660 Level 1 or Level 2 for the disc format.
 - This System can play back MP3/WMA files with the extension code <.mp3> or <.wma> (regardless of the letter case—upper/lower).
 - It is recommended that you make each MP3 file at a sampling rate of 44.1 kHz and at bit rate of 128 kbps. This System cannot play back files made at bit rate of less than 64 kbps.
 - This System can recognize the total of 1000 tracks and of 99 groups (each group can contain up to 150 tracks). Those exceeding the maximum number cannot be recognized.
 - Playback order of MP3/WMA tracks may be different from the one you have intended while recording (see page 40). If a folder does not include MP3/WMA tracks, they are ignored.

Daily Operations—Sound & Other Adjustments (see pages 14 to 16)

Adjusting the Volume:

- Be sure to turn down the volume before connecting or putting the headphones.

Adjusting the Sound:

- This function also affects the sound through the headphones.

Setting the Clock:

- “0:00” will flash on the display until you set the clock.
- The clock may gain or lose 1 to 2 minutes per month. If this happens, reset the clock.

Advanced Radio Operations (see pages 17 to 19)

- If the System takes time to show the RDS information—PS, PTY, RT signals, “WAIT PS,” “WAIT PTY,” or “WAIT RT” will appear while searching.

Unique DVD/VCD Operations (see pages 20 to 22)

- During slow-motion playback, no sound will be reproduced.
- While zoomed in, the picture may look coarse.

Advanced Disc Operations (see pages 23 to 25)

Programming the Playing Order—Program Play:

- If you try to program a 100th track, “MEM FULL” appears on the display.
- While programming steps...
 - Your entry will be ignored if you have tried to program an item number that does not exist on the disc (for example, selecting track 14 on a disc that only has 12 tracks).

Playing at Random—Random Play:

- The ◀◀ button does not work for skipping chapters or tracks, but only work for going back to the beginning of the current chapter or track.

On-Screen Disc Operations (see pages 26 to 30)

- For JPEG files playback...
 - It is recommended that you record a file at 640 x 480 resolution. (If a file has been recorded at a resolution of more than 640 x 480, it will take a long time to be shown.)
 - This System can play only baseline JPEG files. Progressive JPEG files or lossless JPEG files cannot be played.

Baseline JPEG format:	Used for digital cameras, web, etc.
Progressive JPEG format:	Used for web.
Lossless JPEG format:	An old type and rarely used now.
 - This System may not play back JPEG files properly which are recorded by the devices other than digital still camera.
 - If progressive or lossless JPEG files are played back, a black screen appears. In this case, stop playback and select a baseline JPEG file. Note that it may take a long time to select another file.

Timer Operations (see pages 31 to 32)

- When you unplug the AC power cord or if a power failure occurs, the timer will be canceled. You need to set the clock first, then the timer again.
- If you set the Sleep Timer after Daily Timer starts playing the selected source, Daily Timer is canceled.

Setup Menu Operations (see pages 33 to 38)

LANGUAGE:

- When the language you have selected for “MENU LANGUAGE,” “AUDIO LANGUAGE,” or “SUBTITLE” is not recorded on a disc, the original language is used as the initial language.

PICTURE—MONITOR TYPE:

- Even if “4:3 PS” is selected, the screen size may become 4:3 letter box with some DVD Video discs. This depends on how the discs are recorded.
- When you select “16:9” for a picture whose aspect ratio is 4:3, the picture slightly changes due to the process for converting the picture width.

AUDIO—DOWN MIX:

- This setting is not effective when DTS multi-channel software is played back.

OTHERS—ON SCREEN GUIDE:

- Setup Menus and on-screen bar will be displayed (and recorded) even though this function is set to “OFF.” Subtitles and the information for zooming in always appear on the display regardless of this setting.

MP3/WMA/JPEG groups/tracks configuration

This System plays back the tracks as follows.

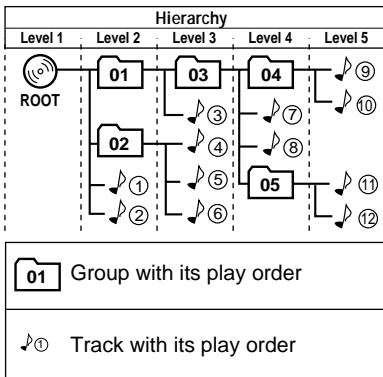

Maintenance

To get the best performance of the System, keep your discs and mechanism clean.

Handling discs

- When removing the disc from its case, hold it at the edge while pressing the center hole lightly.
- Do not touch the shiny surface of the disc, or bend the disc.
- Put the disc back in its case after use to prevent warping.
- Be careful not to scratch the surface of the disc.
- Avoid exposure to direct sunlight, temperature extremes, and moisture.

To clean the disc:

Wipe the disc with a soft cloth in a straight line from center to edge.

Cleaning the System

- Stains should be wiped off with a soft cloth. If the System is heavily stained, wipe it with a cloth soaked in water-diluted neutral detergent and wrung well, then wipe clean with a dry cloth.
- Since the System may deteriorate in quality, become damaged or get its paint peeled off, be careful about the following:
 - DO NOT wipe it with a hard cloth.
 - DO NOT wipe it strongly.
 - DO NOT wipe it with thinner or benzine.
 - DO NOT apply any volatile substance such as insecticides to it.
- DO NOT allow any rubber or plastic to remain in contact for a long time.

To remove the speaker grilles

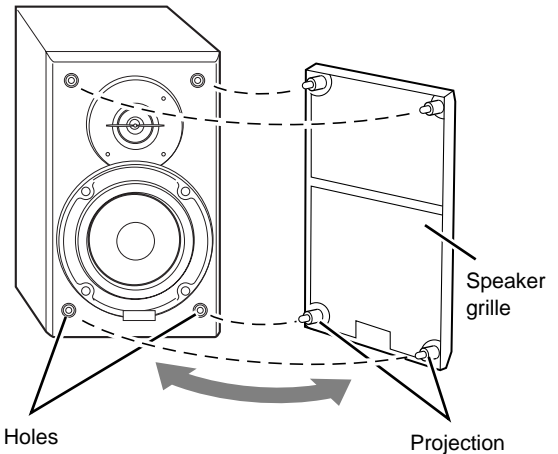

Troubleshooting

If you are having a problem with your System, check this list for a possible solution before calling for service.

General:

Adjustments or settings are suddenly canceled before you finish.

⇒ There is a time limit. Repeat the procedure again.

Operations are disabled.

⇒ The built-in microprocessor may malfunction due to external electrical interference. Unplug the AC power cord and then plug it back in.

Unable to operate the System from the remote control.

⇒ The path between the remote control and the remote sensor on the System is blocked.

⇒ The batteries are exhausted.

No sound is heard.

⇒ Speaker connections are incorrect or loose.

⇒ Headphones are connected.

No picture appears on the screen.

⇒ The video cord connections are incorrect or loose.

No picture is displayed on the TV, the picture is blurred, or the picture is divided into two parts.

⇒ The System is connected to a TV which does not support progressive scanning.

The left and right edges of the picture are missing on the screen.

⇒ Select "4:3 LB" for "MONITOR TYPE" (see page 34).

Radio Operations:

Hard to listen to broadcasts because of noise.

⇒ Antennas connections are incorrect or loose.

⇒ The AM loop antenna is too close to the System.

⇒ The FM antenna is not properly extended and positioned.

Disc Operations:

The disc does not play.

⇒ The disc is placed upside down. Place the disc with the label side up.

ID3 Tag on an MP3/WMA disc cannot be shown.

⇒ There are two types of ID3 Tag—Version 1 and Version 2.

This System can only show ID3 Tag Version 1.

MP3/WMA/JPEG groups and tracks are not played back as you expect.

⇒ The playing order is determined when the disc was recorded. It depends on the writing application.

MP3/WMA or JPEG tracks are not played back.

⇒ The inserted disc may include both type of tracks (MP3/WMA files and JPEG files). In this case, you can only play back the files selected by the "FILE TYPE" setting (see page 35).

⇒ You have changed the "FILE TYPE" setting after you inserted a disc. In this case, reload the disc.

"NO AUDIO" appears.

⇒ This System cannot play back illegally produced DVD Audio discs.

"LR ONLY" appears.

⇒ Some DVD Audio discs prohibit downmixed output. When you play back such a disc, this System plays back the left front and right front signals only.

The disc sound is discontinuous.

⇒ The disc is scratched or dirty.

The disc tray does not open or close.

⇒ The AC power cord is not plugged in.

⇒ Child Lock is in use (see page 25).

Timer Operations:

"CLOCK ADJUST" appears when you press DAILY TIMER on the main unit.

⇒ The built-in clock has not yet been set.

Daily Timer does not work.

⇒ The System has been turned on when the on-time comes. Timer starts working only when the System is turned off.

Daily Timer does not start playback.

⇒ The disc loaded is a DVD video. Change the disc.

⇒ Title/group number and chapter/track number are not entered while setting the Daily Timer. Do not skip these steps when you want to play a disc using Daily Timer.

Setup Menu Operations:

No subtitle appears on the display though you have selected the initial subtitle language.

⇒ Some DVDs are programmed to always display no subtitle initially. If this happens, select the subtitle after starting play (see page 20).

Audio language is different from the one you have selected as the initial audio language.

⇒ Some DVDs are programmed to always use the original language initially. If this happens, select the audio language after starting play (see page 21).

Language Code List

AA	Afar
AB	Abkhazian
AF	Afrikaans
AM	Ameharic
AR	Arabic
AS	Assamese
AY	Aymara
AZ	Azerbaijani
BA	Bashkir
BE	Byelorussian
BG	Bulgarian
BH	Bihari
BI	Bislama
BN	Bengali, Bangla
BO	Tibetan
BR	Breton
CA	Catalan
CO	Corsican
CS	Czech
CY	Welsh
DA	Danish
DZ	Bhutani
EL	Greek
EO	Esperanto
ET	Estonian
EU	Basque
FA	Persian
FI	Finnish
FJ	Fiji
FO	Faroese
FY	Frisian
GA	Irish
GD	Scots Gaelic
GL	Galician
GN	Guarani
GU	Gujarati
HA	Hausa
HI	Hindi
HR	Croatian
HU	Hungarian
HY	Armenian
IA	Interlingua
IE	Interlingue
IK	Inupiak
IN	Indonesian
IS	Icelandic
IW	Hebrew
JI	Yiddish

JW	Javanese
KA	Georgian
KK	Kazakh
KL	Greenlandic
KM	Cambodian
KN	Kannada
KO	Korean (KOR)
KS	Kashmiri
KU	Kurdish
KY	Kirghiz
LA	Latin
LN	Lingala
LO	Laothian
LT	Lithuanian
LV	Latvian, Lettish
MG	Malagasy
MI	Maori
MK	Macedonian
ML	Malayalam
MN	Mongolian
MO	Moldavian
MR	Marathi
MS	Malay (MAY)
MT	Maltese
MY	Burmese
NA	Nauru
NE	Nepali
NL	Dutch
NO	Norwegian
OC	Occitan
OM	(Afan) Oromo
OR	Oriya
PA	Panjabi
PL	Polish
PS	Pashto, Pushto
PT	Portuguese
QU	Quechua
RM	Rhaeto-Romance
RN	Kirundi
RO	Rumanian
RU	Russian
RW	Kinyarwanda
SA	Sanskrit
SD	Sindhi
SG	Sangho
SH	Serbo-Croatian
SI	Singhalese
SK	Slovak

SL	Slovenian
SM	Samoan
SN	Shona
SO	Somali
SQ	Albanian
SR	Serbian
SS	Siswati
ST	Sesotho
SU	Sundanese
SV	Swedish
SW	Swahili
TA	Tamil
TE	Telugu
TG	Tajik
TH	Thai
TI	Tigrinya
TK	Turkmen
TL	Tagalog
TN	Setswana
TO	Tonga
TR	Turkish
TS	Tsonga
TT	Tatar
TW	Twi
UK	Ukrainian
UR	Urdu
UZ	Uzbek
VI	Vietnamese
VO	Volapuk
WO	Wolof
XH	Xhosa
YO	Yoruba
ZU	Zulu

Country/Area Codes List

AD	Andorra
AE	United Arab Emirates
AF	Afghanistan
AG	Antigua and Barbuda
AI	Anguilla
AL	Albania
AM	Armenia
AN	Netherlands Antilles
AO	Angola
AQ	Antarctica
AR	Argentina
AS	American Samoa
AT	Austria
AU	Australia
AW	Aruba
AZ	Azerbaijan
BA	Bosnia and Herzegovina
BB	Barbados
BD	Bangladesh
BE	Belgium
BF	Burkina Faso
BG	Bulgaria
BH	Bahrain
BI	Burundi
BJ	Benin
BM	Bermuda
BN	Brunei Darussalam
BO	Bolivia
BR	Brazil
BS	Bahamas
BT	Bhutan
BV	Bouvet Island
BW	Botswana
BY	Belarus
BZ	Belize
CA	Canada
CC	Cocos (Keeling) Islands
CF	Central African Republic
CG	Congo
CH	Switzerland
CI	Côte d'Ivoire
CK	Cook Islands
CL	Chile
CM	Cameroon
CN	China
CO	Colombia
CR	Costa Rica
CU	Cuba
CV	Cape Verde
CX	Christmas Island
CY	Cyprus
CZ	Czech Republic
DE	Germany
DJ	Djibouti

DK	Denmark
DM	Dominica
DO	Dominican Republic
DZ	Algeria
EC	Ecuador
EE	Estonia
EG	Egypt
EH	Western Sahara
ER	Eritrea
ES	Spain
ET	Ethiopia
FI	Finland
FJ	Fiji
FK	Falkland Islands (Malvinas)
FM	Micronesia (Federated States of)
FO	Faroe Islands
FR	France
FX	France, Metropolitan
GA	Gabon
GB	United Kingdom
GD	Grenada
GE	Georgia
GF	French Guiana
GH	Ghana
GI	Gibraltar
GL	Greenland
GM	Gambia
GN	Guinea
GP	Guadeloupe
GQ	Equatorial Guinea
GR	Greece
GS	South Georgia and the South Sandwich
GT	Guatemala
GU	Guam
GW	Guinea-Bissau
GY	Guyana
HK	Hong Kong
HM	Heard Island and McDonald Islands
HN	Honduras
HR	Croatia
HT	Haiti
HU	Hungary
ID	Indonesia
IE	Ireland
IL	Israel
IN	India
IO	British Indian Ocean Territory
IQ	Iraq
IR	Iran (Islamic Republic of)
IS	Iceland
IT	Italy
JM	Jamaica

JO	Jordan
JP	Japan
KE	Kenya
KG	Kyrgyzstan
KH	Cambodia
KI	Kiribati
KM	Comoros
KN	Saint Kitts and Nevis
KP	Korea, Democratic People's Republic of
KR	Korea, Republic of
KW	Kuwait
KY	Cayman Islands
KZ	Kazakhstan
LA	Lao People's Democratic Republic
LB	Lebanon
LC	Saint Lucia
LI	Liechtenstein
LK	Sri Lanka
LR	Liberia
LS	Lesotho
LT	Lithuania
LU	Luxembourg
LV	Latvia
LY	Libyan Arab Jamahiriya
MA	Morocco
MC	Monaco
MD	Moldova, Republic of
MG	Madagascar
MH	Marshall Islands
ML	Mali
MM	Myanmar
MN	Mongolia
MO	Macau
MP	Northern Mariana Islands
MQ	Martinique
MR	Mauritania
MS	Montserrat
MT	Malta
MU	Mauritius
MV	Maldives
MW	Malawi
MX	Mexico
MY	Malaysia
MZ	Mozambique
NA	Namibia
NC	New Caledonia
NE	Niger
NF	Norfolk Island
NG	Nigeria
NI	Nicaragua
NL	Netherlands
NO	Norway

NP	Nepal
NR	Nauru
NU	Niue
NZ	New Zealand
OM	Oman
PA	Panama
PE	Peru
PF	French Polynesia
PG	Papua New Guinea
PH	Philippines
PK	Pakistan
PL	Poland
PM	Saint Pierre and Miquelon
PN	Pitcairn
PR	Puerto Rico
PT	Portugal
PW	Palau
PY	Paraguay
QA	Qatar
RE	Réunion
RO	Romania
RU	Russian Federation
RW	Rwanda
SA	Saudi Arabia
SB	Solomon Islands
SC	Seychelles
SD	Sudan

SE	Sweden
SG	Singapore
SH	Saint Helena
SI	Slovenia
SJ	Svalbard and Jan Mayen
SK	Slovakia
SL	Sierra Leone
SM	San Marino
SN	Senegal
SO	Somalia
SR	Suriname
ST	Sao Tome and Principe
SV	El Salvador
SY	Syrian Arab Republic
SZ	Swaziland
TC	Turks and Caicos Islands
TD	Chad
TF	French Southern Territories
TG	Togo
TH	Thailand
TJ	Tajikistan
TK	Tokelau
TM	Turkmenistan
TN	Tunisia
TO	Tonga
TP	East Timor
TR	Turkey

TT	Trinidad and Tobago
TV	Tuvalu
TW	Taiwan
TZ	Tanzania, United Republic of
UA	Ukraine
UG	Uganda
UM	United States Minor Outlying Islands
US	United States
UY	Uruguay
UZ	Uzbekistan
VA	Vatican City State (Holy See)
VC	Saint Vincent and the Grenadines
VE	Venezuela
VG	Virgin Islands (British)
VI	Virgin Islands (U.S.)
VN	Vietnam
VU	Vanuatu
WF	Wallis and Futuna Islands
WS	Samoa
YE	Yemen
YT	Mayotte
YU	Yugoslavia
ZA	South Africa
ZM	Zambia
ZR	Zaire
ZW	Zimbabwe

DVD OPTICAL DIGITAL OUT Signals

DIGITAL AUDIO OUTPUT Playback disc	Output Signals		
	STREAM/PCM	DOLBY DIGITAL/PCM	PCM ONLY
DVD Video	48 kHz, 16 bit Linear PCM*		
with 48 kHz, 16/20/24 bit Linear PCM	48 kHz, 16 bit Linear PCM*		
with 96 kHz, Linear PCM	48 kHz, 16 bit Linear PCM		
with Dolby Digital	Dolby Digital bitstream		48 kHz, 16 bit Linear PCM
with DTS	DTS bitstream	48 kHz, 16 bit Linear PCM	
DVD Audio	48 kHz, 16 bit Linear PCM		
with 48/96/192 kHz, 16/20/24 bit Linear PCM	48 kHz, 16 bit Linear PCM		
with 44.1/88.2/176.4 kHz, 16/20/24 bit Linear PCM	44.1 kHz, 16 bit Linear PCM		
with Dolby Digital	Dolby Digital bitstream		48 kHz, 16 bit Linear PCM
with DTS	DTS bitstream	48 kHz, 16 bit Linear PCM	
SVCD, VCD, CD	44.1 kHz, 16 bit Linear PCM/48 kHz, 16 bit Linear PCM		
CD with DTS	DTS bitstream	44.1 kHz, 16 bit Linear PCM	
MP3/WMA disc	32 kHz/44.1 kHz/48 kHz, 16 bit Linear PCM		

* While playing some DVDs, digital signals may be emitted at 20 bits or 24 bits (at their original bit rate) through the DVD OPTICAL DIGITAL OUT terminal if the discs are not copy-protected.

Specifications

Amplifier section

Output Power:

80 W HIGH: 40 W (20 W + 20 W) at 4 Ω (10% THD)
 LOW: 40 W (20 W + 20 W) at 4 Ω (10% THD)

Audio Input AUX: 400 mV/50 kΩ

Digital output: DVD OPTICAL DIGITAL OUT:
 -21 dBm to -15 dBm (660 nm ±30 nm)

Video output:

Color system: PAL (interlaced/progressive)

VIDEO (composite): 1 V(p-p)/75 Ω

S-VIDEO: Y (luminance) 1 V(p-p)/75 Ω

C (chrominance, burst) 0.286 V(p-p)/75 Ω

COMPONENT: (Y) 1 V(p-p)/75 Ω

(Pb/Pr) 0.7 V(p-p)/75 Ω

Speakers/Impedance: 4 Ω – 16 Ω

Tuner section

FM tuning range: 87.50 MHz – 108.00 MHz

AM (MW) tuning range: 522 kHz – 1 629 kHz

Disc player section

Playable disc: DVD Video/DVD Audio

CD/VCD/SVCD

CD-R/CD-RW (CD/SVCD/VCD/MP3/
 WMA/JPEG format)

DVD-R/DVD-RW (Video format)

Dynamic range: 90 dB

Horizontal resolution: 500 lines

Wow and flutter: Immeasurable

Speakers

Speaker units: HIGH: 4 cm cone x 1
 LOW: 10 cm cone x 1

Impedance: HIGH: 4 Ω LOW: 4 Ω

Dimensions (approx.): 145 mm x 230 mm x 202 mm
 (W/H/D)

Mass (approx.): 2.2 kg each

Supplied Accessories

See page 3.

General

Power requirement: AC 230 V ~, 50 Hz

Power consumption: 90 W (at operation)
 1.8 W (on standby)

Dimensions (approx.): 170 mm x 230 mm x 311 mm
 (W/H/D)

Mass (approx.): 5.0 kg

Parts Index

Refer to the pages to see how to use the buttons and controls.

Remote control

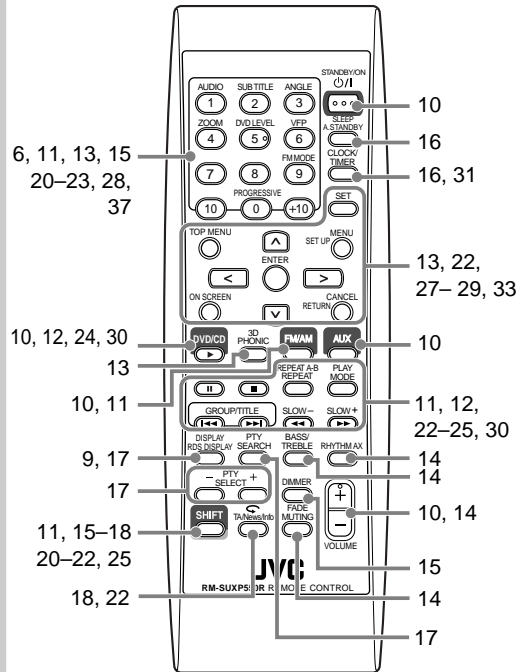

Main unit

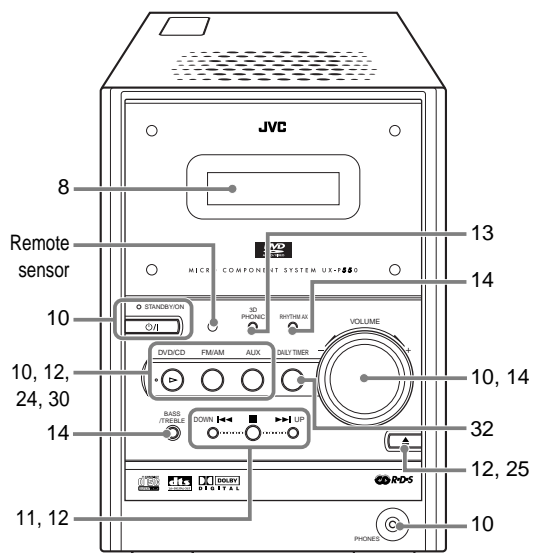

SAFETY INSTRUCTIONS

“SOME DOS AND DON'TS ON THE SAFE USE OF EQUIPMENT”

This equipment has been designed and manufactured to meet international safety standards but, like any electrical equipment, care must be taken if you are to obtain the best results and safety is to be assured.

☆☆

Do read the operating instructions before you attempt to use the equipment.

Do ensure that all electrical connections (including the mains plug, extension leads and interconnections between pieces of equipment) are properly made and in accordance with the manufacturer's instructions. Switch off and withdraw the mains plug when making or changing connections.

Do consult your dealer if you are ever in doubt about the installation, operation or safety of your equipment.

Do be careful with glass panels or doors on equipment.

☆☆

DON'T continue to operate the equipment if you are in any doubt about it working normally, or if it is damaged in any way—switch off, withdraw the mains plug and consult your dealer.

DON'T remove any fixed cover as this may expose dangerous voltages.

DON'T leave equipment switched on when it is unattended unless it is specifically stated that it is designed for unattended operation or has a standby mode.

Switch off using the switch on the equipment and make sure that your family know how to do this. Special arrangements may need to be made for infirm or handicapped people.

DON'T use equipment such as personal stereos or radios so that you are distracted from the requirements of traffic safety. It is illegal to watch television whilst driving.

DON'T listen to headphones at high volume as such use can permanently damage your hearing.

DON'T obstruct the ventilation of the equipment, for example with curtains or soft furnishings. Overheating will cause damage and shorten the life of the equipment.

DON'T use makeshift stands and NEVER fix legs with wood screws—to ensure complete safety always fit the manufacturer's approved stand or legs with the fixings provided according to the instructions.

DON'T allow electrical equipment to be exposed to rain or moisture.

ABOVE ALL

- NEVER let anyone, especially children, push anything into holes, slots or any other opening in the case—this could result in a fatal electrical shock.;
- NEVER guess or take chances with electrical equipment of any kind—it is better to be safe than sorry!

